



Actuators and Accessories

Two position valves switch back and forth between Load and Inject, or Position A and Position B. Selectors operate in continuous revolutions by incremental steps. There are several ways to actuate each type of valve, along with a number of supporting controllers and devices to interface the actuators with computer-controlled systems.

With the exception of low pressure Cheminert selectors, we recommend that selectors be purchased with air or electric actuators. While a manual detent assembly is available, the higher turning torque of our other selector designs makes them more difficult to position accurately by hand.

Manual Actuation

Simplicity and low cost are the main advantages of manual actuation. Some models can be ordered with position feedback, an option which sends a signal to start a data system when the valve is switched.



Knobs
page 204

Air Actuation

Air actuators are useful in situations where any spark could be disastrous or where there is no electricity available. They are small, relatively inexpensive, very rugged and dependable, and field-serviceable. Low gas consumption and lightweight, compact construction make the air actuator suitable for aerospace flight hardware applications as well as laboratory or process applications.

With the addition of a DVI (digital valve interface) to translate the timed event signals into the necessary air pulses, air actuators can be automatically switched by a data system, integrator, or controller such as our DVSP (digital valve sequence programmer) or SVI (serial valve interface).



Air actuator
Two position, page 195
Selector, page 194

MORE INFORMATION Actuators

Air pages 194-195
Microelectric .. 188-191
Standard electric 193

Controllers and Accessories

41E1 198
4-way solenoid air valve
DVI 199
Digital valve interface
DVSP 196
Digital valve sequence programmer
HSSA 198
High speed switching accessory
MSVA 198
Manifold 3-way solenoid valve assembly
PFAF 199
Position feedback for air actuators
RAD 204
Right angle drive
SVI 197
Serial valve interface

Mounting Hardware

Closemount assembly 208-209
Standoff assembly 205-207

CHROMalytic TECHNOlogy Pty Ltd AUSTRALIAN Distributors e-mail: sales@chromtech.net.au Tel: 03 9762 2034

Electric Actuation

The **microelectric actuator** features automatic valve alignment, high-speed switching, compact size, 24 VDC power input, and reversible direction (in the selector model).

If lower cost outranks those factors in your consideration, our **standard electric actuator** (110/230 VAC) offers a dependable, economical solution.

Both types of electric actuators can be operated manually with a controller assembly that features position-indicating LEDs and a toggle

switch, but can be easily connected to an external data system for fully automated control. The microelectric actuator has built-in multidrop RS-232 (RS-485 optional) for bidirectional communications. The SVI (serial valve interface) was designed specifically to interface our standard electric actuators with RS-232 compatible systems, allowing control of up to six actuators via modem, BASIC program, or Valco-supplied PC software.

The new **universal actuator** operates virtually any Valco or Cheminert rotary valve – two position and selector alike – greatly simplifying the electronic aspect of instrument design.



Microelectric actuator
Two position, page 189
For selectors (multiposition), page 190



Standard electric actuator
Two position and selector, page 193



Universal actuator
page 192

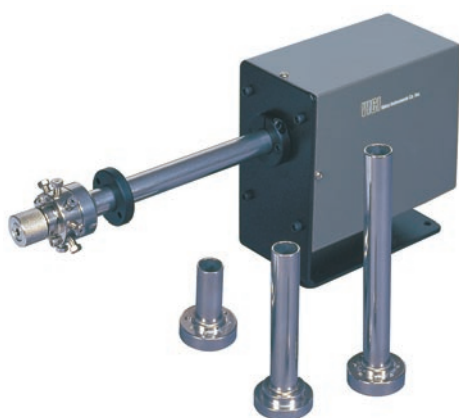

Standoff assemblies
page 205

Standoff Assemblies

All valves, no matter what their actuation mode, can be ordered with a standoff assembly. The standoff is an extension shaft mounted between the handle or actuator and the valve, allowing the valve to be installed within a heated zone while the actuator or handle remains outside at ambient temperature. The standoff extends through the oven wall, and is secured by a clamp ring supplied with the assembly. Standard standoff assembly lengths are 2", 3", 4", and 6". Other lengths can be special-ordered at additional cost.

Right Angle Drive

Some installations don't allow the valve and actuator to be installed in a typical in-line configuration. The RAD (right angle drive) is a 90° gearbox which permits the actuator or handle to be installed at a right angle to the valve. The RAD fits all VICI electric and air actuators.



Right angle drive
page 204

Microelectric Actuators

- CE certified
- Automatic alignment
- Manual control with position indication
- Remote control by contact closures or TTL logic level signals
- RS-232 bidirectional communication (optional RS-485)
- Two position and selector versions
- Universal power supply, 110/230 VAC to 24 VDC
-

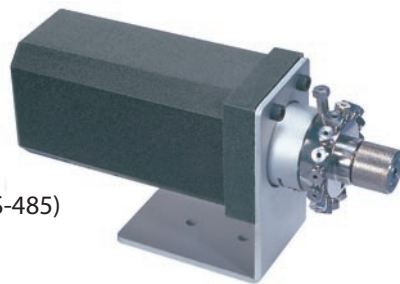

The microelectric actuator offers Valco dependability in a unit which is less than half the size of our standard model. The actuator consists of a control module, a stepper motor/gearbox assembly, a manual remote control, interconnecting cables, and a 110/230 VAC to 24 VDC power supply. The composite version combines the stepper motor/gearbox assembly with the control module. The RS-232 interface cable, if required, must be ordered separately.

Since different valve models have varying actuation torque requirements, there are five microelectric actuator models for two position valves – EQ, EH, EP, ED, and ET – and two versions

for multiposition – EMH and EMT. Consult the chart on the respective ordering information page to determine which model meets your requirements. When a valve and actuator are ordered at the same time, the proper actuator is supplied automatically.

An actuator can be specified with closemount hardware, with a standoff, or with just the standoff mounting hardware, if your valve already has a standoff. The microelectric actuator is designed for room temperature use. Valves which will be mounted in ovens require a standoff assembly, which locates the actuator out of the heated zone.

MORE INFORMATION

Microelectric actuators
For two position 189
For selectors 190-191

Mounting Hardware

Closemount
hardware page 208
Right angle drive 204
Standoff assembly 205
Standoff mounting
hardware 205

TECH TIP

Electric actuators can be directly controlled by signals from microprocessor-based instruments, data systems, or valve programmers, unlike air actuators, which require an interface to convert the signal to an air pulse.

ORDER TIP

To purchase a **valve with a microelectric actuator installed**, see valve ordering information.

Valco

Injectors and
valves pp 102-116
Selectors 122-133

Cheminert

Injectors and
valves 152-167
Selectors 170-177

Two Position Microelectric Actuators



- CE certified
- Stall-sensing circuitry – no mechanical microswitches
- High speed switching – <100 ms in EQ model
- A model for every valve we sell

The two position microelectric actuator features exclusive stall-sensing circuitry which eliminates problems associated with valve/actuator misalignment. Power to the actuator motor is switched off when the driver pin goes against the stop of the valve cutout – no sooner, no later – and it's all done without any mechanical microswitches. Not only does this mean that alignment problems are a thing of the past, it means that you can stock one actuator for valves that turn 30°, 36°, 45°, 60°, 90°, or anything in between.

During initialization, the valve rotates at moderate speed while the actuator waits to sense the stall. Once the rotation angle has been measured and confirmed by repetition, the angle is memorized and actuation takes place at maximum speed. Valve position memory is maintained even in the event of a power failure. There is nothing more to do unless you wish to install a valve with a different angle of rotation. In that event, cycling the actuator with no valve mounted sets up reinitialization.

WHICH MODEL FOR WHICH TWO POSITION VALVE?

Fitting size	Valve type	Actuator model	Valve type	Actuator model
	Valco GC		Valco HPLC	
1/32"	W	EH	W	EP
1/16"	W	EH	W	EP
1/16"	UW	ED	UW	ED
1/8"	UW	ED	UW	ED
1/4"	MW	ET	—	—

Cheminert HPLC & Low Pressure

All valves E H

SPEED AND TORQUE: Inversely proportional

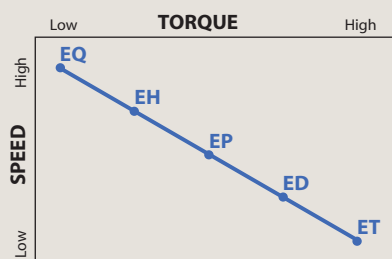

Microelectric actuators

for two position valves

Standard voltage 24 VDC. Includes autosensing 24 VDC power supply. Standoff version includes a 2" standoff. 3", 4", and 6" standoffs are also available. Consult the chart below to determine which actuator model is best suited for your valve.

Description	With closemount assembly Prod No	With 2" standoff assembly Prod No	For use with existing standoff Prod No
Highest speed actuator	EQ	EQ2	EQS
High speed actuator	EH	EH2	EHS
Medium torque actuator	EP	EP2	EPS
High torque actuator	ED	ED2	EDS
Highest torque actuator	ET	ET2	ETS

RS-232 interface cable

Description	Prod No
RS-232 interface cable	I-22697

TECH TIP

Multi-drop cables permit a single serial port (RS-232) to control multiple microelectric actuators.

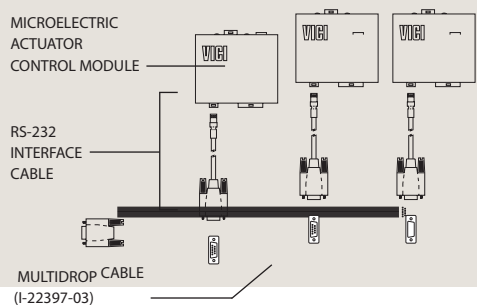

Multi-drop cables

for multiple microelectric actuators

Multi-drop cables permit a single serial port (RS-232) to control multiple microelectric two position and multiposition actuators. Cables have one female DB9 and 2 to 8 male DB9 connectors – approximately 6" long.

Note: The RS-232 interface cable (I-22697), above, is required for **each** actuator.

No. of actuators to be controlled	Prod No
2	I-22897-02
3	I-22897-03
4	I-22897-04
5	I-22897-05
6	I-22897-06
8	I-22897-08

Microelectric Actuators for Selectors

- CE certified
- Direction reversal
- Position indication
 - LED display
 - RS-232 output
 - BCD 5V negative true output
- Manual control
 - Step and home functions
 - Clockwise and counterclockwise functions
- Remote control
 - Step and home functions with contact closure
 - Direct position access with BCD 5V negative true input
 - Direct position access with RS-232 input (RS-485 optional)
- Automatic self-alignment with keyed valves and standoffs



One actuator can be used on any selector, from 2 to 96 positions – you tell the actuator how many stops to make through its 360° of rotation. So you can stock only one type of actuator even if you have 4, 6, 8, 10, 12, and 16 position valves. Valve position memory is maintained even in the event of a power failure.

The direction reversal feature means that if a 6 position stream selection valve is on stream 1 and you select stream 6, you have the option of stepping “backwards” to stream 6 instead of passing through 2, 3, 4, and 5. The RS-232 input offers various commands like position access, direction control, shortest route, etc. (The RS-232 cable must be ordered separately.)

MORE INFORMATION

Microelectric actuators
For two position 189

Mounting Hardware

Closemount
hardware page 208
Right angle drive 204
Standoff assembly 205
Standoff mounting
hardware 205

ORDER TIP

To purchase a **valve with a microelectric actuator installed**, see valve ordering information.

Valco

Injectors and
valves pp 102-116
Selectors 122-133

Cheminert

Injectors and
valves 152-167
Selectors 170-177

Microelectric Actuators for Selectors

Microelectric actuators

for selectors

Standard voltage 24 VDC. Includes autosensing 24 VDC power supply.
Standoff version includes a 2" standoff. 3", 4", and 6" standoffs are also available.
Consult the chart below to determine which actuator model is best suited for your valve.

Description	With keyed closemount assembly Prod No	With keyed 2" standoff assembly Prod No	For use with existing standoff Prod No
High speed actuator	EMH	EMH2	EMHS
High torque actuator	EMT	EMT2	EMTS

WHICH MODEL FOR WHICH SELECTOR?

Valve model Actuator model

Valco

All valves EMT

Cheminert high pressure

C5 4, 6 positions EMH
 8, 10 positions EMT
 C75NX EMH
 C75H EMH

Cheminert low pressure

C25Z EMH
 C25 EMH
 C35Z EMH
 C45 EMT

RS-232 interface cable

Description	Prod No
RS-232 interface cable	I-22697

Multi-drop cables

for multiple microelectric actuators

Multi-drop cables permit a single serial port (RS-232) to control multiple microelectric two position and selector actuators. Cables have one female DB9 and 2 to 8 male DB9 connectors – approximately 6" long.

Note: The RS-232 interface cable (I-22697), above, is required for **each** actuator.

No. of actuators to be controlled	Prod No
2	I-22897-02
3	I-22897-03
4	I-22897-04
5	I-22897-05
6	I-22897-06
8	I-22897-08

TECH TIP

Multi-drop cables permit a single serial port (RS-232) to control multiple microelectric actuators.

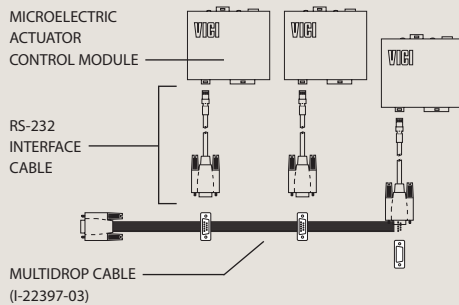

ABOUT STANDOFFS

Keyed standoff assemblies are used with selector (multiposition) microelectric actuators, to key the valve body to the actuator and standoff so that the actuators can self-align and operate valves with any number of positions.

Valco selectors are not keyed unless ordered with a microelectric actuator. To install a microelectric actuator on an existing Valco selector, the key (pin) must be removed from the actuator clamp ring assembly. This can be done easily with a pair of pliers.

See page 207, top and bottom illustrations, for drawings of keyed standoff assemblies with multiposition microelectric actuators.

NEW OEM – Universal Actuators

- One actuator works with two position valves *and* selectors
- Simplified, universal communication protocol
- Variety of interfaces
- Three versions for various valve torque requirements



The universal actuator allows instrument manufacturers to use a single motor and control software to operate virtually any Valco or Cheminert rotary valve. This simplifies the electronic aspect of instrument design and streamlines the development process.

All our Valco and Cheminert valves and selectors, with their wide range of turning torques, are covered by three actuator versions: high speed, medium speed/medium torque, and high torque. (See charts below)

Actuators listed below include universal 24 volt DC power supply and manual interface. An OEM version that excludes these items is also available. Current interface options include RS232/485, USB, and BCD.

While the actuators listed on this page are universal, the valve mounting hardware is not. The product numbers shown below do not include the hardware required for mounting a valve, since the necessary hardware depends on the valve type. If you are ordering the actuator for use

with an *existing* valve, call our sales or technical staff to determine the correct hardware needed. If you want to order the universal actuator with a *new* valve, simply substitute the actuator product number in place of a different actuator and we'll provide the correct hardware. For example, to order the universal actuator in place of the air actuator in A4C6UWE, order p/n EUD4C6UWE, or to order C2-2006EH with a universal actuator, order C2-2006EUH.

NEW Universal actuators

	High speed (EUH)	Medium torque (EUD)	High torque (EUT)
<i>Description</i>	<i>Prod no</i>	<i>Prod no</i>	<i>Prod no</i>
Without interface	EUH	EUD	EUT
With RS-232/485	EUHA	EUDA	EUTA
With USB	EUHB	EUDB	EUTB
With BCD	EUHC	EUDC	EUTC



Refer to these charts to determine which of the three versions best suits the valves you use, or simply ask our sales or technical staff.

WHICH MODEL FOR WHICH SELECTOR?

Valco	Actuator model	Actuator model
All valves	EUT	
Cheminert	Actuator model	Actuator model
	HPLC	UHPLC
4 and 6 position *	EUH	EUH
8 and 10 position	EUD	EUD
	Low pressure	
Model C25 and C25Z	EUH	
Model C35Z	EUD	
Model C45	EUT	
* 20,000 psi versions use EUD.		

WHICH MODEL FOR WHICH INJECTOR / TWO POSITION VALVE?

Valco			
Fitting size	Valve type	Actuator model	Actuator model
		GC	HPLC
1/32"	W	EUH	EUD
1/16"	W	EUH	EUD
1/16"	UW	EUD	EUD
1/8"	UW	EUD	EUD
1/4"	MW	EUT	—
Cheminert			
		Actuator model	Actuator model
		HPLC	UHPLC
4 and 6 ports *		EUH	EUH
8 and 10 ports		EUH	EUD
		Low pressure	
All valves		EUH	
*20,000 psi versions use EUD.			

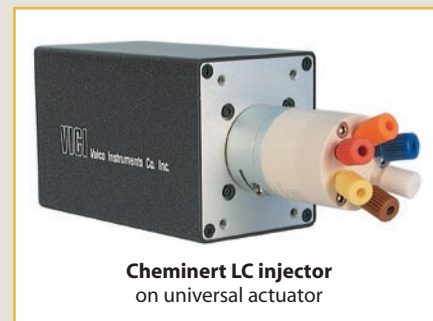

Standard Electric Actuators



Two position standard electric actuators may be operated manually by a toggle switch or automatically by any data system with momentary contact closures or 5 VDC negative true logic outputs. A complete system, the actuator includes interface cable, power cord, and manual controller assembly with position indication.

Multiposition (selector) models work with any of our multiposition valves. The manual controller with LED display allows the user to step sequentially from one position to the next or to return to Position 1 (Home). A data system with momentary contact closures can direct the step and home functions; 5 VDC negative true logic outputs provide direct position access. A 20-conductor interface

cable permits the system to step the actuator sequentially, move the actuator directly to any position, and read the actual valve position.

Standard electric actuators can be ordered with closemount hardware, a standoff, or just the standoff mounting hardware, if your valve already has a standoff. Valves which will be mounted in ovens require a standoff assembly so that the actuator is located out of the heated zone.

The actuator's rotation (two position) or number of positions (multiposition) must be properly matched to the valve's. If you are converting a manual valve to electric actuation and have any doubts about which actuator and hardware you need, call our sales or technical staff for assistance.

ORDER TIP

To purchase a **valve with a standard electric actuator installed**, see valve ordering information.

Valco

Injectors and valves pp 102-116
Multiposition valves 122-133

Cheminert

Injectors and valves 152-167
Multiposition valves 170-177

TECH TIP

Valco two position W and UW type valves and Cheminert valves have the following angles of rotation:

3 port	90°
4 port	90°
6 port	60°
8 port	45°
10 port	36°
12 port	30°
14 port	26°

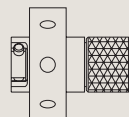

Valco

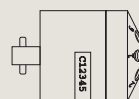

Cheminert

MORE INFORMATION Controllers

DVSP page 196
Digital valve sequence programmer
SVI 197
Serial valve interface

Mounting Hardware

Closemount hardware 208
Right angle drive . 204
Standoff assembly 205
Standoff mounting hardware 205

Standard electric actuators

for two position valves

Standard voltage: 110 VAC. (230 VAC and 24 volt CE versions optional. Consult factory for product numbers and pricing.)

Standoff version includes a 2" standoff. 3", 4", and 6" standoffs are also available.

No. of ports in valve	Description	With closemount assembly	With 2" standoff assembly	For use with existing standoff
		Prod No	Prod No	Prod No
3, 4	90° rotation	E90	E902	E90S
6	60° rotation	E60	E602	E60S
8	45° rotation	E45	E452	E45S
10	36° rotation	E36	E362	E36S
12	30° rotation	E30	E302	E30S

Standard electric actuators

for selectors

Standard voltage: 110 VAC. (230 VAC optional. Consult factory for product numbers and pricing.)
Standoff version includes a 2" standoff. 3", 4", and 6" standoffs are also available.

Description	With closemount assembly	With 2" standoff assembly	For use with existing standoff
	Prod No	Prod No	Prod No
4 position	E4	E42	E4S
4 x 2*	E4X2	E4X22	E4X2S
6 position	E6	E62	E6S
6 x 2**	E6X2	E6X22	E6X2S
8 position	E8	E82	E8S
10 position	E10	E102	E10S
12 position	E12	E122	E12S
16 position	E16	E162	E16S

* The 4 column selection valve, CST4UW, is an 8 position valve and needs a 4 x 2 actuator.

** The 6 column selection valve, CST6UW, is a 12 position valve and needs a 6 x 2 actuator.