

Value Plastics

FLUID MANAGEMENT

Components



Nordson
MEDICAL

v.027

Welcome to Nordson MEDICAL's Interactive Catalog!

In order to meet the needs of our customers, Nordson MEDICAL has chosen to develop a user-friendly tool that allows for quick and easy access to our vast selection of parts, along with their specifications and technical information. Within this PDF, you will enjoy the following features:

Part Description and Image Hyperlinks

Click on each part to view pricing, see part drawings, and add parts to your shopping cart.

Various Messages Within Sections

These messages will link you to product line details such as datasheets and part drawings.

Online Technical Information

Use the catalog's technical charts to link to online data.

Bookmarks and Interactive Table of Contents

For easy navigation, use these tools to jump to different product lines within the catalog.

Barb Style Descriptions

Click on this section to access specifications for each style.

Material Data Panels

Refer to these side panels for definitions of part extensions and click to view material data online.

In-Text References

E-mails, page number, and website references will link you to the appropriate location.

Designer Kit Details

Click on designer kit headers to view part maps.

Interactive Index

This tool allows you to quickly access a specific part within the catalog.

Search Capabilities

Use the search tool to find keywords throughout the PDF.

Offline Access

Download the catalog and save it to your computer for quick and easy offline access!

INTRODUCTION.....	4	LUERS.....	58
BIOMATERIAL DELIVERY DEVICES.....	6	Male.....	59
CATHETER SOLUTIONS.....	6	Female.....	61
FACILITY LOCATIONS.....	7	Adapters and Couplers.....	63
WHAT'S NEW.....	8	Tees.....	63
INTERNATIONAL RESOURCES.....	9	Elbows.....	63
ISO 80369.....	10	Plugs and Caps.....	64
ISO 80369-3 (Enteral Feeding) Compliant Connectors.....	12	Luer to Thread.....	65
ISO 80369-5 (Blood Pressure) Compliant Connectors.....	13	Panel Mounts.....	66
DESIGN CENTER.....	14	Panel Mount Accessories.....	67
QUICK CONNECTS.....	16	BLOOD PRESSURE.....	68
MQC Series Female Fittings.....	16	BPF Series.....	68
MQC Series Male Fittings.....	17	Bayonet Male Cuff Connectors.....	69
PQC Series Female Fittings.....	17	Bayonet Panel Mount Connectors.....	69
PQC Series Male Fittings.....	20	Dinamap® Monitor Adapters.....	69
RQC Series Female Fittings.....	24	Dinamap® Cuff Connectors.....	70
RQC Series Male Fittings.....	24	BPL Series.....	71
RQX Series Female Fittings.....	25	BPLF 1/4 Turn Cuff Connectors.....	71
RQX Series Male Fittings.....	25	TUBE-TO-TUBE.....	72
SBL Series Female Fittings.....	26	Straight Through.....	73
SBL Series Male Fittings.....	26	Straight Through Reducer.....	75
XQ Series Female Fittings.....	27	Elbow.....	78
XQ Series Male Fittings.....	28	Elbow Reducer.....	79
CHECK VALVES.....	30	Tee.....	80
Single Check Valves - Anti-Siphon.....	30	Tee Reducer.....	81
High Flow Check Valve.....	31	Y.....	83
Single Check Valves - One-Way.....	31	Multiport.....	84
Single Check Valves - Barbed.....	32	Press-In Plugs.....	86
Double Check Valves.....	33	Ultrasonically Weldable Barbs.....	87
NEEDLEFREE SWABABLE VALVES.....	34	Panel Mounts.....	87
Swabable Straight Valves.....	34	Panel Mount Accessories.....	87
Swabable Y Valves.....	35	THREADED.....	88
Bondable Valve.....	35	10-32 UNF, Special Tapered Thread.....	89
Swabable Bag Valve.....	35	1/4-28 UNF.....	92
Swabable Break-Off Valves.....	35	1/4-28 UNF Bottom Sealing.....	93
Tube End Valves.....	35	Metric M6x1.....	94
13 mm Swabable Vial Cap.....	35	Metric M5x.8.....	94
20 mm Swabable Vial Cap.....	35	1/16-27 NPT.....	95
Swabable T-Port Valve.....	35	1/8-27 NPT.....	96
4-Way Lever Swabable Stopcock.....	35	1/4-18 NPT Reducers.....	97
STOPCOCKS.....	36	BUILD-A-PART.....	98
1-Way Stopcocks.....	36	Junction Blocks.....	99
3-Way Stopcocks.....	37	Accessories.....	100
4-Way Stopcocks.....	37	Barbs.....	100
BIOPROCESS FITTINGS.....	38	Threads.....	101
Bag Ports.....	38	TUBING.....	102
Opposing Barb Ports.....	41	Polyvinyl Chloride (PVC).....	102
BioClamp®.....	42	Polyurethane.....	103
BioValve®.....	43	Low Density Polyethylene.....	103
Gaskets.....	44	Silicone.....	103
PharmaLok™ Clamps.....	45	Thermoplastic Elastomer (TPE).....	103
RQC Series Quick Connects.....	48	OTHER COMPONENTS.....	104
RQX Series Quick Connects.....	49	Tapered Seal.....	104
Sanitary Fittings - Mini Flange.....	50	Clamps.....	106
Sanitary Fittings - Maxi Flange.....	51	Injection Sites.....	106
Large Tube-to-Tube Connectors.....	52	Spikes.....	106
TUOHY BORST ADAPTERS.....	56	TUBESETTER® Assembly Tool.....	107
Adult Without Side Port.....	57	Designer Kits.....	108
Pediatric Without Side Port.....	57	TECHNICAL INFORMATION.....	110
Adult With Side Port.....	57	Barb Dimensions.....	110
		Barb Performance.....	112
		BPF Series Properties and Performance Data.....	113
		Panel Mount Instructions.....	113
		Resin Information.....	114
		Trademarks.....	117
		Index.....	118

©2015 Nordson MEDICAL. All rights reserved. No part of this catalog may be reproduced without the expressed written consent of Nordson MEDICAL. All terms are current as of August 1, 2015 and are subject to change without notice.

 <p>HROMalytic +61(0)3 9762 2034</p>	<p>Australian Distributors Importers & Manufacturers www.chromtech.net.au</p>
 <p>ECHnology Pty Ltd</p>	
<p>Website NEW : www.chromalytic.net.au E-mail : info@chromtech.net.au Tel: 03 9762 2034 . . . in AUSTRALIA</p>	

Welcome to Nordson MEDICAL!

Thank you for your interest in our products. If you're a current customer, we appreciate your business and look forward to exceeding your expectations in the future. If you're seeing us for the first time, we welcome the opportunity to earn your trust.

Nordson MEDICAL is your partner in the global life sciences market bringing you the combined excellence of Value Plastics' precision plastic fluid components, biomaterial delivery devices, and Avalon Laboratories' catheter solutions, along with a wide range of capabilities, services, and customized OEM solutions.

Nordson MEDICAL is backed by the extensive resources of Nordson Corporation (Nasdaq: NDSN), the world leader in precision dispensing, fluid management and related technologies.

What We Do

The Value Plastics product line includes over 4,000 fluid management components designed specifically for flexible tubing in different style and material combinations. Products include quick connect fittings, luer fittings, check valves, bioprocessing fittings, tube-to-tube fittings, threaded fittings and blood pressure monitoring components with tubing IDs ranging from 1/16" to 1". We also offer custom component manufacturing, tubing, select medical OEM components and our TUBESETTER® fitting inserters to facilitate device assembly. Our application expertise extends to bioprocessing, blood pressure, cardiovascular, ophthalmic, and more. Value Plastics products find global application in demanding healthcare OEM, research and specialty industrial applications.

Your Assurance of VP Quality

How can you be sure that you're getting a genuine Value Plastics® fitting? Look for the Value Plastics logo. Molded into every fluid management component we manufacture, this logo is your assurance you are producing the highest quality items. By relying on our superior tooling and craftsmanship, you can be assured that you will have the best OEM tubing components in your products.

To protect our intellectual property and our customers, it is important to be aware of the patents and trademarks that apply to our products. Look for the Value Plastics logo (VP) to ensure you do not mistakenly use a poor quality counterfeit of a Value Plastics® fitting, thereby jeopardizing the integrity and quality of your product. Many attributes of our components are covered by patent, including but not limited to, barb, grips, function and other design features.

Our Quality Commitment to You

At Nordson MEDICAL, quality is designed in from the outset; it's not an add-on at the end of the process. We are an FDA registered manufacturing facility and our Quality Management System is designed as a system of interrelated processes meeting the requirements of ISO 13485 and ISO 9001. We welcome our customers to conduct an on-site supplier audit with the knowledge that our systems have satisfied the most demanding requirements of medical device manufacturers worldwide. We are dedicated to exceeding your expectations.



Clean Room Manufacturing

Most Nordson MEDICAL products are manufactured and packaged in an environment that meets the requirements of ISO 14644-1 Class 8 (Class 100,000) standards. We utilize both manual and automated assembly processes tailored to manufacture the highest quality components, biomaterial delivery systems, and catheter solutions.

Assembly and Finishing Capabilities

Utilizing hypotube bending, ultrasonic welding and polymer solution casting, Nordson MEDICAL's quality products are sophisticated and reliable. We have a solid reputation in today's medical device and biotech markets with pressure and leak testing. We also offer manual, semi-automatic, and fully automatic finished good assembly.

Design, Engineering and R&D

Nordson MEDICAL's staff of product development professionals uses the most modern equipment to design the best products available anywhere. Whether your need is for new products or custom solutions, our focus on healthcare OEMs means we understand your needs and don't need to be coached to your industry requirements. Designs incorporating human factors, finite element analysis, DFMA, rapid prototyping and concurrent engineering are just some of the tools used to bring you the components you require, when you want them.

Manufacturing Consistency

Nordson MEDICAL is equipped with multiple injection molding machines including plastic injection molding and over molding including 2-shot and insert molding. Our all-electric injection molding presses are chosen for shot-to-shot consistency and outfitted with the most up-to-date process monitoring software available. Each operator is responsible for product quality at the press and has every tool at their disposal. All molding, secondary operations and packaging take place in a controlled environment to assure component readiness for your production floor.

Rapid Prototyping

Nordson MEDICAL's engineering department is a leader in the industry. Using rapid prototyping and an in-house, high performance 3D printer, we can utilize multiple resins to provide certain material properties to components. We can execute highly representative prototypes and build a mold in two days, allowing us to deliver solutions with testable parts in a short time.

We use a system to verify potential product performance to expedite quality product design and development. The use of several tooling technologies allows us to incorporate innovative materials and processes to provide plastic components in a fraction of the time it may take to utilize metals.

We also execute detailed processes for evaluating application requirements to ensure the design focuses on ease of use, cost efficiency, design manufacturability, and top notch performance.

Regulatory Management

Nordson MEDICAL strives to provide our customers with the most up-to-date technical information, directly from the resin manufacturer, on the resins we use. We maintain a comprehensive list of all material and regulatory information, enabling you to select the most appropriate products for your particular application. Information we provide includes:

- Regulatory data
- Material data
- MSDS
- Typical resin properties
- Sterilization stability information
- Chemical resistance information

Visit www.nordsonmedical.com for technical information.

Custom Packaging and Labeling

Nordson MEDICAL has the ability to provide custom packaging, labeling and private branding to meet your needs, including:

- Trays
- Artwork
- IFUs
- Customized product labels
- Orders made to your specifications
- Unique packaging Information

Customer Satisfaction

As with all of our medical parts, each bag comes with a product certification and traceable lot number. Our parts are manufactured and bagged in a clean room environment to accelerate your own usage.

At Nordson MEDICAL, we are dedicated to exceeding your expectations. As such, it is important to us that when you place an order you know exactly what to expect, when to expect it and that we will do everything we can to ensure that you receive components made to the required specifications.

Nordson MEDICAL implements and regulates an internal customer support system. Our goal is to provide you exceptional service and quality solutions. We track all support issues in order to meet ISO requirements, enhance customer satisfaction, and to continuously improve our initiatives.

When a support issue concerns one of our products, we begin an immediate investigation of our available stock and quarantine any suspected parts. We then complete all required formal corrective actions and inform the customer when the issue is resolved.

To contact customer service, please call us at (888) 404-5837 or (970) 267-5200.

Contact Us

Visit us at www.nordsonmedical.com for all your low pressure fluid management needs.

OsteoPrecision™ and OsteoXpress™ Graft Delivery Devices

Nordson MEDICAL's graft delivery devices are designed to deliver allograft, autograft or synthetic bone graft materials to an orthopedic surgical site.

In addition, they are designed to facilitate the premixing of bone graft materials with fluids such as IV fluids, blood, plasma, platelet rich plasma, bone marrow or other specified blood components as deemed necessary by the clinical use requirements.

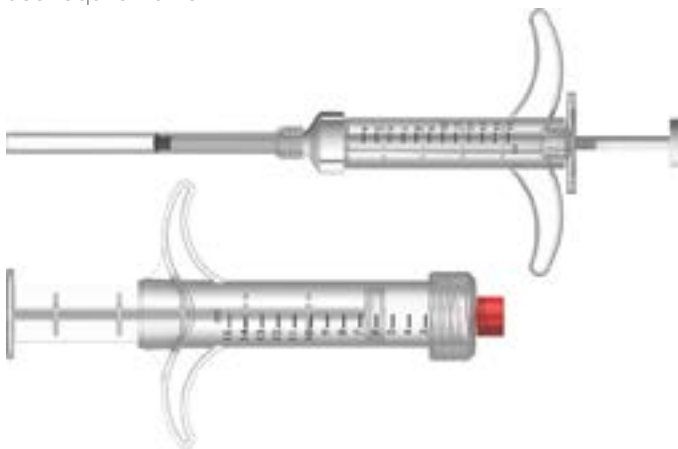

FibriJet® Biomaterial Applicators and Tips

The FibriJet line of biomaterial applicators and tips is the "gold standard" featuring proven designs of single use applicators and tips for the dispensing of single and multi-component biomaterial. Our biomaterial delivery systems offer modularity and flexibility to meet the needs of many surgical procedures.

FibriJet biomaterial applicators and tips are used to accurately control and dispense biomaterials such as tissue sealants, hemostats, and concentrated plasma gel to control bleeding, heal wounds, and other related medical procedures. Single and dual syringe applicators and an extensive line of interchangeable tips meet the particular needs of specific surgical procedures. FibriJet products dispense a single material or simultaneously dispense two materials to a localized treatment site with simple, one-handed operation.



Polymer Solution Casting™

The Avalon product line includes cannulae, wire-reinforced catheters and specialized medical tubing. Avalon's polymer solution casting™ technology provides the ability to add multiple components, varying wall thickness or diameter along the length of a medical device. Customized medical tubing options include single to multi-lumens, coil, braid or hypotube reinforcements, bump tubing, imaging targets, custom atraumatic, tapered and reinforced tips, holes or ports, and lubricious surfaces available in a single piece construction. Avalon offers secondary operations (pad printing, tipping, skiving, hole punching, forming, bonding, custom branding, packaging and labeling) and sub-assembly to finished device services.

Polymer solution casting methods allow us to incorporate materials with different properties including strength, lubricity, flexibility, color and multi-lumens - to customize tubing for any application.

Avalon has a full team of engineers that create uncompromising, cost-effective medical devices. Our engineering expertise includes development, manufacturing, quality and material science.



We Have Moved

We are very proud and excited to have built a new manufacturing facility on a 116 acre site in Loveland, Colorado to meet growing demand in medical end markets for its Value Plastics brand of engineered, single-use plastic-molded fluid management components and to provide flexibility and capacity for continued long term growth.

The state-of-the-art, 115,000 square foot facility is located seven miles away from our previous Fort Collins facility and is self-contained from in-house product design through tooling, manufacturing, assembly and packaging. Customer support, sales and marketing resources support the world from this single facility.

If you have any questions about our location change or the Validation Master Plan, please contact your Nordson Medical account manager or customer service at (888) 404-5837.

Nordson MEDICAL

805 West 71st Street
 Loveland, CO 80538

Loveland, Colorado Facility

- 115,000 square foot facility
- Clean room molding and packaging
- ISO 13485 and ISO 9001 certified
- Highly automated facility
- NPD and design services
- R&D/testing lab
- FDA registered



Eagan, Minnesota Facility

Our biomaterial delivery technology center is located in Eagan, Minnesota, just outside of St. Paul.



Guaymas, Mexico and Rancho Dominguez, California Facilities

Avalon currently operates two FDA-registered and ISO 13485 certified facilities in California and Mexico.

- FDA registered
- ISO 13485 certified
- Manufacturing of complex products



ISO 80369 Compliant Connectors

Nordson MEDICAL now offers compliant connectors for the new ISO 80369-3 standards for enteral and gastric small bore connectors as well as the ISO 80369-5 limb cuff inflation standards for blood pressure cuffs. **PG-12**



Nordson MEDICAL's Quick Connect Line is Incredible

Incredibly broad - We have over 170 quick connect configurations, arguably the most extensive line of quick connect couplers developed exclusively for the medical market.

Incredibly versatile - Our quick connector series now offer a full range of fluid path diameters from 1/8" to 1/2" in push-to-connect, quarter-turn, thumb latch, and side-latch connections. Also, the available pressure range is staggering, with a variety of sealing surfaces to choose from. The connectors also offer resin choices that afford multiple sterilization options, MRI compatibility, animal-free options, as well as bioburden, cytotoxicity, and extractable testing data available upon request. **PG-16**



PQC Series Small Bore Quick Connects

PQC Series products are produced in acetal and polypropylene in four configurations – threaded, inline straight, elbows and panel mounts. These quick connectors bring performance and convenience to your tubing applications. Offered in small tubing sizes to fit 1/8" (3.2 mm) and 1/4" (6.4 mm) ID tubing, the 3200 Series triple barb style works well with semi-rigid tubing. **PG-17**



High Flow Check Valve

Featuring a flowrate $\geq 3,000$ ml/min with water at a pressure of 1 bar, our high flow check valve fits 8.8 O.D. tubing sizes and has a back pressure of 1 bar/14.5 psig. The check valve is designed for flushing and irrigation applications and for use with certain insufflation tubing sets used in minimally invasive surgeries. **PG-31**



FC Series Stopcocks

Nordson MEDICAL's stopcocks are designed to easily control the flow of a liquid or gas through the use of an on/off diverter, and are available in three basic configurations – 1-way, 3-way, and 4-way. These chemically resistant stopcocks are available as standard or high flow and are offered in polycarbonate, PEI and nylon with HDPE diverters. **PG-36**



RENOLIT SOLMED Granuflex 4301 Resin

Nordson MEDICAL is now offering our popular bag ports made with RENOLIT SOLMED Granuflex 4301 resin. These products demonstrate lower leachable levels and high purity. **PG-39**



PharmaLok™ Clamps

Nordson MEDICAL's line of PharmaLok™ clamps feature a state-of-the-art design that simplifies the assembly process by making it effortless to securely attach sanitary fittings to bag ports and filters. All PharmaLok™ clamps are ASME BPE compliant and operate at a maximum pressure of 80 psi. Single-use and easy-open clamp sizes include .5" to .75" and 1" to 1.5", and the tube clamp supports tubing sizes from .5" to 1.25". The tube clamp is also designed for use with silicone and TPE tubing. **PG-45**



RQX Series Quick Connects

RQX Series quick connects feature unsurpassed ergonomics with a large locking button for easier handling and connection as well as a single barb open flow design. Available in widely used polypropylene and polycarbonate materials, these connectors are compatible with industry standard quick connects to simplify qualification and fit 3/8" and 1/2" tubing sizes. **PG-49**



TBA Series Tuohy Borst Adapters

Tuohy Borst adapters are designed to facilitate catheter introduction and are intended for interventional and diagnostic procedures where fluid backflow is a concern. **PG-56**



Need Samples for Evaluation?

You can call to request most of our standard product in quantities of 5, or less, for free application evaluation.

+1 (970) 267-5200 Toll Free: (888) 404-5837

EUROPE:

We take our customer relationships very seriously by providing competitive pricing, live-body technical support, superior quality parts, and a friendly customer service staff to process your orders in a timely manner.

Jean Gastaldi

European Business Development Manager
Phone: +33 687 753 458
Email: jean.gastaldi@nordsonmedical.com

Andrew Grabau

International Sales Associate
Phone: 970-226-8270
Email: andrew.grabau@nordsonmedical.com

Technical Service/Quotes

Nordson MEDICAL
805 West 71st Street
Loveland, CO 80538 USA
Phone: 970-267-5200
Email: sales@nordsonmedical.com

SOUTH AMERICA:**R.D.V. International**

Juan Benigno Vela 08-60 y Castillo
Ambato, Ecuador
Phone: +593-3-285-4369
Fax: +593-3-282-6358
Email: rdvusarep@comcast.net

R.D.V. International
Countries:
Argentina
Bolivia
Columbia
Chile
Ecuador
Peru
Uruguay
Venezuela

Trusty Comércio e Representações Ltda.

Av. J K de Oliveira, 580 - Sala 23
Guaratinguetá - SP 12.505-300
Brazil
Phone: +55 12 3132-3560
Fax: +55 12 3132-3463
Email: jgalhardo@tcr-brazil.com.br

TCR Countries:
Brazil

ASIA:**Air Dynamics Pte Ltd**

180 Paya Lebar Road
#03-03 Yi Guang Factory Building
Singapore, 409032
Phone: +65-6746 6884
Fax: +65-6743 0687
Email: richard.lee@airdynamics.com.sg
www.airdynamics.com.sg

Air Dynamics Pte
Ltd Countries:
Singapore
Malaysia
Indonesia
Philippines

Cole-Parmer

403-404, B-Wing, Delphi
Hiranandani Business Park, Powai
Phone: +91-22-6716-2222
Fax: +91-22-6716-2211
Email: info@coleparmer.in
www.coleparmer.in

Cole-Parmer
Countries:
India

ISIS

1-1-36, Nishi-Awaji
Higashi-Yodogawa-Ku
Osaka 533-0031 Japan
Phone: +81-6-6325-1406
Fax: +81-6-6328-8995
Email: mail@isis-ltd.co.jp
www.isis-ltdco.jp

ISIS Countries:
Japan

Sanwa

NBF Urawa-Building
2-5, Higashi-Takasagocho, Urawa-Ku,
Saitama-City, Saitama-Prefecture,
Japan 330-0055
Phone: +81 048-871-0501
Fax: +81 048-871-0502
Email: info@sanwa-ent.co.jp
www.sanwa-ent.co.jp

Sanwa Countries:
Japan

AUSTRALIA / NEW ZEALAND:**John Morris Scientific Pty Ltd**

61-63 Victoria Ave.
Chatswood, NSW 2067 Australia
Phone: +61 2 9496 4200
Enquiry Phone: 1800 251 799
Email: info@johnmorris.com.au
www.johnmorris.com.au

John Morris
Scientific Countries:
Australia
New Zealand

What is ISO 80369

Hospitals and other healthcare facilities depend on a variety of catheters, tubing and syringes to deliver medications and other substances to patients through vascular, enteral, respiratory, epidural and intrathecal delivery systems. These delivery systems frequently employ fittings called luer connectors to link various system components. Unfortunately, because luer connectors are ubiquitous, easy-to-use, and compatible between different delivery systems, end users can inadvertently connect the incorrect systems together. These misconnections can cause medication or other fluids to be delivered through the wrong route, resulting in serious patient injuries and even death. In an effort to reduce the occurrence of these misconnections, the FDA is actively participating internationally to develop and implement standards for the non-interconnectability of small bore medical connectors. A joint working group established by the International Organization for Standardization (ISO) and the International Electrotechnical Commission (IEC) leads this effort to develop a series of standards for incompatible connectors. ISO 80369-1 is the first in the series of standards and establishes the applications specified below that will have their own unique connector geometries.

ISO 80369-1

General Requirements

- This standard is already published
- The second edition is currently in ballot
- Comments from this DIS ballot were reviewed partially in March, 2015
- Discussions were held to remove the definition of Small Bore from the standard to prevent it from limiting the connector size
 - The committee agreed to remove the number references
- The committee also discussed the following:
 - Allowing softer materials in sealing surfaces
 - Allowing proprietary connectors to claim compliance to 80369-1
- The standard is expected to be updated to a second edition later in 2016

ISO 80369-2

Respiratory (Breathing Systems)

- The task group now comprises of many global players from the industry
- DIS draft is complete, and the ballot is open
- R1 and R2 designs are changing to address misconnections and dead space
- The standard is expected to release by the end of 2016

ISO 80369-3

Enteral Feeding

- DIS with the proposed connector designs has passed with many favorable votes in the recent ballot
- FDA issued a notification to manufacturers of medical devices with connectors recognizing AAMI's US Provisional Standard for Enteral until the final 80369-3 is published: www.fda.gov
- Efforts to delay the implementation of CA Mandate Bill AB 1847 has passed through multiple steps and is awaiting the Governor's signature. A successful resolution will push the deadline to July, 2016.
- The standard is expected to be released by the end of 2015

ISO 80369-4

Urinary and Urethral

- No updates at this time



i8.nordsonmedical.com

ISO 80369-5

Blood Pressure (Limb Cuff Inflation)

- Connector test protocol and validation tests with respect to interconnectability and functionality are complete
- The standard is expected to publish by the end of 2015

ISO 80369-6

Neuraxial Devices

- Standard work is in ISO, Geneva
- Efforts to delay the implementation of CA Mandate Bill AB 1847 has passed through multiple steps and is awaiting the Governor's signature. A successful resolution will push the deadline to January, 2017.
- The standard is expected to be published by the end of 2015

ISO 80369-7

Intravascular (IV) or Hypodermic

- DIS complete
- Validation testing is underway
- FDIS submission still to happen
- The standard is expected to publish in early 2016

When Will it Come into Effect?

ISO 80369-1 is published and active currently. There are several requirements that can be followed to ensure non-interconnectability with connector sets based on criteria outlined within the standard. Determining the exact time the 80369 sub-standards will come into effect can be a difficult task as they are still under development. Our team is on the front lines in the development of these standards, allowing us great insight to when these standards will be released. We will be updating our website regularly to when these changes will occur as we get more information.

How Does it Impact Me?

Compliance with the ISO 80369 standard may require major changes on the part of medical device manufacturers. In the next few years, if these standards are approved it could mean new designs, new parts, new moldings and updating or replacing millions of components. The 80369 standard series will eventually define connector set geometries for specific applications, meaning new connectors will be needed to replace luers in a multitude of areas. Nordson MEDICAL has taken a very active role in the development of these standards to help reduce the impact of this change on our customers.

How Can I Prepare?

While the standards have not yet been completely established, the main precaution that medical device manufacturers can take to help prevent any future problems is to stay up-to-date on ISO 80369 news. Nordson MEDICAL is one of only a few connector companies worldwide actively participating on ISO 80369 committees. To keep the medical device community apprised of new developments, we have chosen to provide information in one web location. Nordson MEDICAL has set up an online resource to help medical device OEMs stay informed of the changes and updates to this standard.

To read the latest updates, subscribe to alerts, and view related resources, go to Nordson MEDICAL's online resource at i8.nordsonmedical.com.

ISO 80369

Compliant Connectors



ISO 80369-3 (Enteral Feeding) Compliant Connectors PG-13



With the publication of new ISO 80369 standards for small bore connectors, Nordson MEDICAL is well positioned to help you with your tubing connection needs. Our parts are tested and documented to be compliant with this new standard. Because Nordson MEDICAL's Value Plastics product line team has participated on the committees deriving these standards, you can be assured of a full understanding of the testing and compliance requirements.

ISO 80369-3

Enteral Feeding

The new ISO 80369-3 standards for enteral and gastric small bore connectors (also called ENFIT connectors) offer a smaller, lightweight, smoother design for more comfort, less snagging, and easier cleaning. Both the male connector (patient side) and female connector (supply side), offer a one-piece tethered cap for easy assembly and use. The standard SKUs cover a wide range of tubing sizes, from 5 French to 10 French, with the easy ability to customize bond-in pocket sizes for your specific tubing requirements. We offer a barbed version for silicone tubing and all of the materials are medical-grade resins to conform with biocompatibility requirements.

Our standard products are manufactured in natural resins without color additives, however we can customize your purchases with purple, orange, or other colors as required with a 10,000 piece minimum order quantity. Our bond-in socket connectors are standard in ABS and our barbed version is an animal-free polypropylene material. These materials are well proven in the medical field to sterilize and clean-up well, and to offer chemical resistance for various foods, lipids, and drugs.

ISO 80369-5 (Blood Pressure) Compliant Connectors PG-13



Extension Sets

ISO 80369-3 (ENFIT) compliant extension sets are also available and can be customized to meet your specific needs. We offer a variety of tubing diameter sizes, lengths, and materials, with or without tethered caps. Please contact Nordson MEDICAL to discuss your requirements.



ENTME050 (-8003)

Enteral Male Connector with 5.0 FR Tubing Bond-In Pocket in Natural ABS



ENTME064 (-8003)

Enteral Male Connector with 6.4 FR Tubing Bond-In Pocket in Natural ABS



ENTME078 (-8003)

Enteral Male Connector with 7.8 FR Tubing Bond-In Pocket in Natural ABS



ENTME098 (-8003)

Enteral Male Connector with 9.8 FR Tubing Bond-In Pocket in Natural ABS



ENTM230 (-6005)

Enteral Male Connector Barb for 1/8" (3.2 mm) ID Tubing in Animal-Free Polypropylene



ENTFE098 (-8003)

Enteral Female Connector with 10 FR Tubing Bond-In Pocket in Natural ABS



ISO 80369-3 Accessories:

Tethered caps and plugs are not covered under the ISO 80369-3 standard, but are compatible with our enteral male and female connectors.

ENTFTC (-VP1)

Tethered Cap for Enteral Female Connector in Animal-Free Polyethylene



ENTMTP (-VP1)

Tethered Plug for Enteral Male Connector in Animal-Free Polyethylene



ISO 80369-5

Blood Pressure

Nordson MEDICAL continues to offer a wide range of connectors for non-invasive blood pressure (NIBP) monitoring equipment. With the publication of the new ISO 80369-5 limb cuff inflation standard for blood pressure cuffs, many organizations will move towards this new worldwide standard – bayonet-style connectors. The tight dimensional specifications for the compliant connectors will drastically reduce the probability of a misconnection. Nordson MEDICAL has already modified designs for parts to be 100% compliant with the blood pressure male connectors that fit singly or in pairs on blood pressure cuffs.

These industry-standard male connectors work well with the Nordson MEDICAL female blood pressure connectors, Parker/Rectus connectors, and other bayonet-style females, both compliant and non-compliant. And the Nordson MEDICAL single-barb designs offer an excellent secure connection with better tensile pull results and hydrostatic burst testing results than traditional multi-barb designs. The toughness of the DuPont Zytel nylon is well proven, and Nordson MEDICAL has been making these connectors for more than a decade.

ISO 80369-5 COMPLIANT PARTS:
 Bayonet Male Cuff Connectors

BPM013 (-1)

Blood Pressure Monitor Bayonet Connector to 500 Series Barb, 80369-5 Compliant, 1/8" (3.2 mm) ID Tubing



BPM240 (-1)

Blood Pressure Monitor Bayonet Connector to 200 Series Barb, 80369-5 Compliant, 5/32" (4.0 mm) ID Tubing



BPM025 (-1)

Blood Pressure Monitor Bayonet Connector to 500 Series Barb, 80369-5 Compliant, 5/32" (4.0 mm) ID Tubing



BPM035 (-1)

Blood Pressure Monitor Bayonet Connector to 500 Series Barb, 80369-5 Compliant, 3/16" (4.8 mm) ID Tubing



DESIGN

Center



“It would have taken me two to three times as long and two to three times as much money without Nordson MEDICAL. This is who you want to work with. They have become part of our team.”



Fitting The World's Most Fluid Designs

How it Works:

- 1 Define Your Product Requirements:**

Describe your application and requirements or provide us with a drawing or simple sketch. From here we can determine what details are needed and can help define the most ideal and cost-effective connector concept for your application.
- 2 Call the Design Center to Explore Your Connector Options:**

There may be a suitable off-the-shelf solution or perhaps we can adapt an existing connector to your application. Often the modification of an existing mold can be significantly faster and less expensive.
- 3 Collaborate:**

Working with your requirements, we can help walk you through the most cost effective solutions to achieve your desired performance. That may mean simply taking 2 or 3 connectors and identifying a low-cost means to roll them into a single connector.
- 4 Go-to-Market:**

As we arrive at a solution together, we closely involve your team in the design and development process to ensure that as we approach production you have everything you need for qualification to get you to market both quickly and safely. The rest is up to you!



What happens when “off-the-shelf” just doesn’t work? The Design Center builds a new shelf!

Your Solution. Faster. For Less.

With project requirements and timelines becoming increasingly demanding, it's critical to partner with a team who understands fluid management solutions and the rigors of today's medical device and biotech markets. Team up with the Nordson MEDICAL Design Center for your custom connector needs, whose market leading service, quality and delivery you've already come to know.

Here's What You Can Expect From Our Design Center and the “Specialists in Fluid Connections”:

Save Time – Talk to someone who understands your application requirements. The Design Center works with you to determine the most suitable material and design options to deliver the best performing product as cost-effectively as possible. We also utilize state of the art rapid prototyping techniques and in-house testing facilities to keep your project moving quickly and economically.

Save Money – Start with our existing product offering of over 4,000 fluid connectors, or utilize some of our existing mold configurations toward perfectly customizing a part to your application. Don't forget, our technical and design assistance is FREE!

Save Trouble – Ensure that everything around your project will be done right the first time. Our dedicated and experienced staff will make sure that the finest details are covered from the time that we review your product requirements to the final product qualification.

The Design Center can also assist you in developing fluid connectors that comply to emerging standards. Nordson MEDICAL is an active member of the ISO 80369 standards group defining new standard connectors for small bore, medical device connections.

Custom Assembly – Our knowledgeable team of engineers offers capabilities to the biotechnical market through custom-made assemblies created in our design center. From systems using a single fitting to complex configurations utilizing various components, we can design complete assemblies to your requirements.

To get started today contact your Nordson MEDICAL Design Services Manager:
Toll Free - +1 (866) 582-0965
Email - designcenter@nordsonmedical.com
dc.nordsonmedical.com

QUICK CONNECT

Fittings



MQC Series Female Fittings
PG-16



MQC Series Male Fittings
PG-17



PQC Series Female Fittings
PG-17



PQC Series Male Fittings
PG-20



RQC Series Female Fittings
PG-24



RQC Series Male Fittings
PG-24



RQX Series Female Fittings
PG-25



RQX Series Male Fittings
PG-25



SBL Series Female Fittings
PG-26



SBL Series Male Fittings
PG-26



XQ Series Female Fittings
PG-27



XQ Series Male Fittings
PG-28



Our medical quick connect line is incredible -

Nordson MEDICAL's quick connect line offers six distinct families of quick connect fittings (quick disconnect couplings), the MQC, PQC, RQC, RQX, SBL, and XQ Series products, for applications covering 1/8" (3.2 mm) through 1/2" (12.7 mm) ID tubing.

MQC Series

Quick Connects

The MQC Series is an easy to use Push-to-Connect design and arguably one of the most versatile quick connect solutions on the market. With its large, ergonomic buttons and wide selection of colors, both designers and end users will embrace its unique features. The MQC Series of connectors are available in nylon and fit 1/8" (3.2 mm), 5/32" (4.0 mm) and 3/16" (4.8 mm) ID tubing. Between its versatility, one-of-a-kind design, and loud "click" indicating a secure fit, misconnects will be a problem of the past!

MQC SERIES: Female Open Flow

MQCF230 (-1 -2 -3 -4 -5 -8)

Dual Latch Quick Connect Female 200 Series Barb 1/8" (3.2 mm) Tubing ID



MQCF240 (-1 -2 -3 -4 -5 -8)

Dual Latch Quick Connect Female 200 Series Barb 5/32" (4.0 mm) Tubing ID



MQCF250 (-1 -2 -3 -4 -5 -8)

Dual Latch Quick Connect Female 200 Series Barb 3/16" (4.8 mm) Tubing ID



MQC SERIES:
Male Open Flow

MQCRM230 (-001 -002 -003 -004 -005 -08B)

Nylon, Buna-N O-Ring

Dual Latch Quick Connect Male 200 Series Barb 1/8" (3.2 mm) Tubing ID



-001 White Nylon
-005 Blue Nylon

MQCRM240 (-001 -002 -003 -004 -005 -08B)

Nylon, Buna-N O-Ring

Dual Latch Quick Connect Male 200 Series Barb 5/32" (4.0 mm) Tubing ID



-001 White Nylon
-005 Blue Nylon

MQCRM250 (-001 -002 -003 -004 -005 -08B)

Nylon, Buna-N O-Ring

Dual Latch Quick Connect Male 200 Series Barb 3/16" (4.8 mm) Tubing ID



-001 White Nylon
-005 Blue Nylon

MQC SERIES:
Male and Female Sets

MQCMF230-901

Bag of 50 Dual Latch Quick Connect Male and Female Sets, 200 Series Barb 1/8" (3.2 mm) Tubing ID, Blue Female and White Male



MQCMF240-901

Bag of 50 Dual Latch Quick Connect Male and Female Sets, 200 Series Barb 5/32" (4.0 mm) Tubing ID, Blue Female and White Male



MQCMF250-901

Bag of 50 Dual Latch Quick Connect Male and Female Sets, 200 Series Barb 3/16" (4.8 mm) Tubing ID, Blue Female and White Male



PQC Series
Quick Connects

PQC Series products are produced in acetal and polypropylene in four configurations – threaded, inline straight, elbows and panel mounts. These quick connectors bring performance and convenience to your tubing applications. Offered in small tubing sizes to fit 1/8" (3.2 mm) and 1/4" (6.4 mm) ID tubing, the 3200 Series triple barb style works well with semi-rigid tubing.

QUICK
CONNECTS

PQC SERIES:
Female Open Flow Threaded

PQCF18-AC-001

Female Open Flow Connector, 1/8-27 NPT Thread, Natural Acetal



PQCF18-PP-001

Female Open Flow Connector, 1/8-27 NPT Thread, Almond Polypropylene



PQCF18-PP-002

Female Open Flow Connector, 1/8-27 NPT Thread, Grey Polypropylene



PQCF14-AC-001

Female Open Flow Connector, 1/4-18 NPT Thread, Natural Acetal

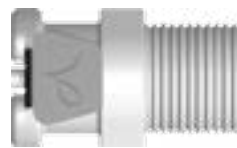

PQCF14-PP-001

Female Open Flow Connector, 1/4-18 NPT Thread, Almond Polypropylene



PQCF14-PP-002

Female Open Flow Connector, 1/4-18 NPT Thread, Grey Polypropylene



PQC SERIES:
Female Valved Threaded

PQCVF18-AC-001
Female Valved Connector, 1/8-27 NPT Thread, Natural Acetal, Buna-N O-Ring

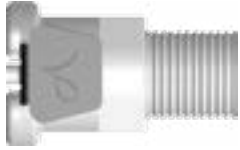

PQCVF18-PP-001
Female Valved Connector, 1/8-27 NPT Thread, Almond Polypropylene, EPDM O-Ring



PQCVF18-PP-002
Female Valved Connector, 1/8-27 NPT Thread, Grey Polypropylene, EPDM O-Ring



PQCVF14-AC-001
Female Valved Connector, 1/4-18 NPT Thread, Natural Acetal, Buna-N O-Ring

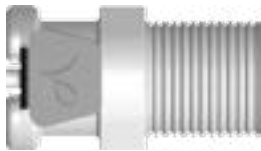

PQCVF14-PP-001
Female Valved Connector, 1/4-18 NPT Thread, Almond Polypropylene, EPDM O-Ring



PQCVF14-PP-002
Female Valved Connector, 1/4-18 NPT Thread, Grey Polypropylene, EPDM O-Ring



PQC SERIES:
Female Open Flow Inline Straight (Barbed)

PQCF3230-AC-001
Female Open Flow Connector, 3200 Series Barb, 1/8" (3.2 mm) Tubing ID, Natural Acetal



PQCF3230-PP-001
Female Open Flow Connector, 3200 Series Barb, 1/8" (3.2 mm) Tubing ID, Almond Polypropylene



PQCF3230-PP-002
Female Open Flow Connector, 3200 Series Barb, 1/8" (3.2 mm) Tubing ID, Grey Polypropylene



PQCF3260-AC-001
Female Open Flow Connector, 3200 Series Barb, 1/4" (6.4 mm) Tubing ID, Natural Acetal



PQCF3260-PP-001
Female Open Flow Connector, 3200 Series Barb, 1/4" (6.4 mm) Tubing ID, Almond Polypropylene



PQCF3260-PP-002
Female Open Flow Connector, 3200 Series Barb, 1/4" (6.4 mm) Tubing ID, Grey Polypropylene



QUICK CONNECTS

PQC SERIES:**Female Valved Inline Straight (Barbed)****PQCVF3230-AC-001**

Female Valved Connector, 3200 Series Barb, 1/8" (3.2 mm) Tubing ID, Natural Acetal, Buna-N O-Ring

**PQCVF3230-PP-001**

Female Valved Connector, 3200 Series Barb, 1/8" (3.2 mm) Tubing ID, Almond Polypropylene, EPDM O-Ring

**PQCVF3230-PP-002**

Female Valved Connector, 3200 Series Barb, 1/8" (3.2 mm) Tubing ID, Grey Polypropylene, EPDM O-Ring

**PQCVF3260-AC-001**

Female Valved, 3200 Series Barb, 1/4" (6.4 mm) Tubing ID, Natural Acetal, Buna-N O-Ring

**PQCVF3260-PP-001**

Female Valved Connector, 3200 Series Barb, 1/4" (6.4 mm) Tubing ID, Almond Polypropylene, EPDM O-Ring

**PQCVF3260-PP-002**

Female Valved Connector, 3200 Series Barb, 1/4" (6.4 mm) Tubing ID, Grey Polypropylene, EPDM O-Ring

**PQC SERIES:****Female Open Flow Panel Mount (Barbed)****PQCBF3230-AC-001**

Female Open Flow Panel Mount Connector with 1/2-24 UNS thread, 3200 Series Barb, 1/8" (3.2 mm) Tubing ID, Natural Acetal, Ni-Plated Brass Hex Nut

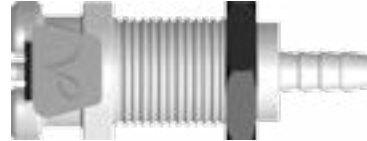
**PQCBF3230-PP-001**

Female Open Flow Panel Mount Connector with 1/2-24 UNS thread, 3200 Series Barb, 1/8" (3.2 mm) Tubing ID, Almond Polypropylene, Ni-Plated Brass Hex Nut

**PQCBF3230-PP-002**

Female Open Flow Panel Mount Connector with 1/2-24 UNS thread, 3200 Series Barb, 1/8" (3.2 mm) Tubing ID, Grey Polypropylene, Ni-Plated Brass Hex Nut

**PQCBF3260-AC-001**

Female Open Flow Panel Mount Connector with 1/2-24 UNS thread, 3200 Series Barb, 1/4" (6.4 mm) Tubing ID, Natural Acetal, Ni-Plated Brass Hex Nut

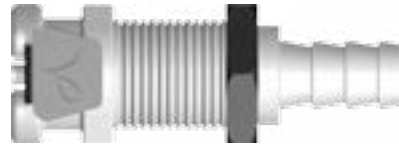
**PQCBF3260-PP-001**

Female Open Flow Panel Mount Connector with 1/2-24 UNS thread, 3200 Series Barb, 1/4" (6.4 mm) Tubing ID, Almond Polypropylene, Ni-Plated Brass Hex Nut

**PQCBF3260-PP-002**

Female Open Flow Panel Mount Connector with 1/2-24 UNS thread, 3200 Series Barb, 1/4" (6.4 mm) Tubing ID, Grey Polypropylene, Ni-Plated Brass Hex Nut



QUICK
CONNECTS

PQC SERIES:

Female Valved Panel Mount (Barbed)

PQCVBF3230-AC-001

Female Valved Panel Mount Connector with 1/2-24 UNS Thread, 3200 Series Barb, 1/8" (3.2 mm) Tubing ID, Natural Acetal, Buna-N O-Ring, Ni-Plated Brass Hex Nut

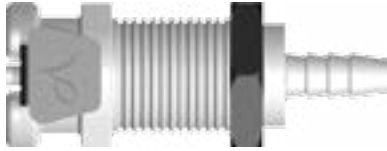

PQCVBF3230-PP-001

Female Valved Panel Mount Connector with 1/2-24 UNS Thread, 3200 Series Barb, 1/8" (3.2 mm) Tubing ID, Almond Polypropylene, EPDM O-Ring, Ni-Plated Brass Hex Nut



PQCVBF3230-PP-002

Female Valved Panel Mount Connector with 1/2-24 UNS Thread, 3200 Series Barb, 1/8" (3.2 mm) Tubing ID, Grey Polypropylene, EPDM O-Ring, Ni-Plated Brass Hex Nut



PQCVBF3260-AC-001

Female Valved Panel Mount Connector with 1/2-24 UNS Thread, 3200 Series Barb, 1/4" (6.4 mm) Tubing ID, Natural Acetal, Buna-N O-Ring, Ni-Plated Brass Hex Nut

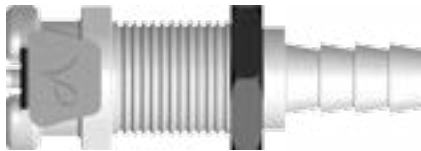

PQCVBF3260-PP-001

Female Valved Panel Mount Connector with 1/2-24 UNS Thread, 3200 Series Barb, 1/4" (6.4 mm) Tubing ID, Almond Polypropylene, EPDM O-Ring, Ni-Plated Brass Hex Nut



PQCVBF3260-PP-002

Female Valved Panel Mount Connector with 1/2-24 UNS Thread, 3200 Series Barb, 1/4" (6.4 mm) Tubing ID, Grey Polypropylene, EPDM O-Ring, Ni-Plated Brass Hex Nut



PQC SERIES:

Male Open Flow Threaded

PQCM18-AC-001

Male Open Flow Connector, 1/8-27 NPT Thread, Natural Acetal, Buna-N O-Ring



PQCM18-PP-001

Male Open Flow Connector, 1/8-27 NPT Thread, Almond Polypropylene, EPDM O-Ring



PQCM18-PP-002

Male Open Flow Connector, 1/8-27 NPT Thread, Grey Polypropylene, EPDM O-Ring



PQCM14-AC-001

Male Open Flow Connector, 1/4-18 NPT Thread, Natural Acetal, Buna-N O-Ring



QUICK CONNECTS

Custom Assembly

We produce standard components to fit your current assemblies and devices, but we also provide custom solutions by applying a variety of assembly options, such as joining fittings, connectors, filters, and other components to tubing. From systems using a single fitting to complex configurations utilizing various components, we can design complete assemblies to your requirements.

PQC SERIES:
Male Valved Threaded

PQCV18-AC-001

Male Valved Connector, 1/8-27 NPT Thread, Natural Acetal, Buna-N O-Ring



PQCV18-PP-001

Male Valved Connector, 1/8-27 NPT Thread, Almond Polypropylene, EPDM O-Ring



PQCV18-PP-002

Male Valved Connector, 1/8-27 NPT Thread, Grey Polypropylene, EPDM O-Ring



PQCV14-AC-001

Male Valved Connector, 1/4-18 NPT Thread, Natural Acetal, Buna-N O-Ring



PQC SERIES:
Male Open Flow Inline Straight (Barbed)

PQCM3230-AC-001

Male Open Flow Connector, 3200 Series Barb, 1/8" (3.2 mm) Tubing ID, Natural Acetal, Buna-N O-Ring



PQCM3230-PP-001

Male Open Flow Connector, 3200 Series Barb, 1/8" (3.2 mm) Tubing ID, Almond Polypropylene, EPDM O-Ring



PQCM3230-PP-002

Male Open Flow Connector, 3200 Series Barb, 1/8" (3.2 mm) Tubing ID, Grey Polypropylene, EPDM O-Ring



PQCM3260-AC-001

Male Open Flow Connector, 3200 Series Barb, 1/4" (6.4 mm) Tubing ID, Natural Acetal, Buna-N O-Ring



PQCM3260-PP-001

Male Open Flow Connector, 3200 Series Barb, 1/4" (6.4 mm) Tubing ID, Almond Polypropylene, EPDM O-Ring



PQCM3260-PP-002

Male Open Flow Connector, 3200 Series Barb, 1/4" (6.4 mm) Tubing ID, Grey Polypropylene, EPDM O-Ring



QUICK
CONNECTS

Need Samples for Evaluation?

You can call to request most of our standard product in quantities of 5, or less, for free application evaluation.

+1 (970) 267-5200 Toll Free: (888) 404-5837

Need More Details?

Check out the MQC, PQC, RQ, SBL, and XQ Datasheets at www.nordsonmedical.com or contact Sales at sales@nordsonmedical.com.

PQC SERIES:

Male Valved Inline Straight (Barbed)

PQCV3230-AC-001

Male Valved Connector, 3200 Series Barb, 1/8" (3.2 mm) Tubing ID, Natural Acetal, Buna-N O-Ring

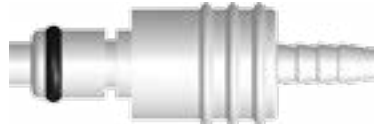

PQCV3230-PP-001

Male Valved Connector, 3200 Series Barb, 1/8" (3.2 mm) Tubing ID, Almond Polypropylene, EPDM O-Ring



PQCV3230-PP-002

Male Valved Connector, 3200 Series Barb, 1/8" (3.2 mm) Tubing ID, Grey Polypropylene, EPDM O-Ring

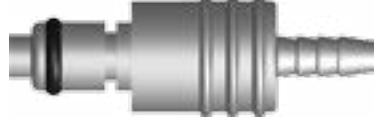

PQCV3260-AC-001

Male Valved Connector, 3200 Series Barb, 1/4" (6.4 mm) Tubing ID, Natural Acetal, Buna-N O-Ring



PQCV3260-PP-001

Male Valved Connector, 3200 Series Barb, 1/4" (6.4 mm) Tubing ID, Almond Polypropylene, EPDM O-Ring



PQCV3260-PP-002

Male Valved Connector, 3200 Series Barb, 1/4" (6.4 mm) Tubing ID, Grey Polypropylene, EPDM O-Ring



PQC SERIES:

Male Open Flow Elbow (Barbed)

PQCLM3230-AC-001

Male Open Flow Elbow Connector, 3200 Series Barb, 1/8" (3.2 mm) Tubing ID, Natural Acetal, Buna-N O-Ring



PQCLM3230-PP-001

Male Open Flow Elbow Connector, 3200 Series Barb, 1/8" (3.2 mm) Tubing ID, Almond Polypropylene, EPDM O-Ring



PQCLM3230-PP-002

Male Open Flow Elbow Connector, 3200 Series Barb, 1/8" (3.2 mm) Tubing ID, Grey Polypropylene, EPDM O-Ring

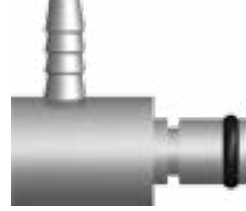

PQCLM3260-AC-001

Male Open Flow Elbow Connector, 3200 Series Barb, 1/4" (6.4 mm) Tubing ID, Natural Acetal, Buna-N O-Ring



PQCLM3260-PP-001

Male Open Flow Elbow Connector, 3200 Series Barb, 1/4" (6.4 mm) Tubing ID, Almond Polypropylene, EPDM O-Ring



PQCLM3260-PP-002

Male Open Flow Elbow Connector, 3200 Series Barb, 1/4" (6.4 mm) Tubing ID, Grey Polypropylene, EPDM O-Ring



QUICK CONNECTS

PQC SERIES:

Male Valved Elbow (Barbed)

PQCVLM3230-AC-001

Male Valved Elbow Connector, 3200 Series Barb, 1/8" (3.2 mm) Tubing ID, Natural Acetal, Buna-N O-Ring



PQCVLM3230-PP-001

Male Valved Elbow Connector, 3200 Series Barb, 1/8" (3.2 mm) Tubing ID, Almond Polypropylene, EPDM O-Ring

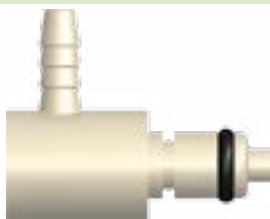

PQCVLM3230-PP-002

Male Valved Elbow Connector, 3200 Series Barb, 1/8" (3.2 mm) Tubing ID, Grey Polypropylene, EPDM O-Ring



PQCVLM3260-AC-001

Male Valved Elbow Connector, 3200 Series Barb, 1/4" (6.4 mm) Tubing ID, Natural Acetal, Buna-N O-Ring



PQCVLM3260-PP-001

Male Valved Elbow Connector, 3200 Series Barb, 1/4" (6.4 mm) Tubing ID, Almond Polypropylene, EPDM O-Ring



PQCVLM3260-PP-002

Male Valved Elbow Connector, 3200 Series Barb, 1/4" (6.4 mm) Tubing ID, Grey Polypropylene, EPDM O-Ring



PQC SERIES:

Male Open Flow Panel Mount (Barbed)

PQCBM3230-AC-001

Male Open Flow Panel Mount Connector with 1/2-24 UNS Thread, 3200 Series Barb, 1/8" (3.2 mm) Tubing ID, Natural Acetal, Buna-N O-Ring, Ni-Plated Brass Hex Nut



PQCBM3260-AC-001

Male Open Flow Panel Mount Connector with 1/2-24 UNS Thread, 3200 Series Barb, 1/4" (6.4 mm) Tubing ID, Natural Acetal, Buna-N O-Ring, Ni-Plated Brass Hex Nut



PQC SERIES:

Male Valved Panel Mount (Barbed)

PQCVBM3230-AC-001

Male Valved Panel Mount Connector with 1/2-24 UNS Thread, 3200 Series Barb, 1/8" (3.2 mm) Tubing ID, Natural Acetal, Buna-N O-Ring, Ni-Plated Brass Hex Nut



PQCVBM3260-AC-001

Male Valved Panel Mount Connector with 1/2-24 UNS Thread, 3200 Series Barb, 1/4" (6.4 mm) Tubing ID, Natural Acetal, Buna-N O-Ring, Ni-Plated Brass Hex Nut



QUICK
CONNECTS

Part Drawings Online!

Nordson MEDICAL provides dimensional drawings available for download for all of its fittings.

www.nordsonmedical.com

RQSeries

Quick Connects

 QUICK
CONNECTS

Nordson MEDICAL has developed a more robust alternative for bioprocessing needs with the RQC Series and RQX Series offering a cost effective solution for flexible tubing connections in single use systems. The connector set is best in fit, form and function, and features a user-friendly interface that includes a large guarded button for a secure lock to guard against disconnects, and lofted lead-in for improved ease of connection. The more reliable locking feature gives you peace of mind knowing your connection is secure.

Features & Benefits:

- Materials meet USP Class VI and ISO 10993 criteria
- Several connector configurations available in commonly used polypropylene and polycarbonate materials
- Large ergonomic button and thumb pad with secure latch and optional integrated locking mechanism
- Platinum-cured silicone o-rings
- Plugs and caps available to maintain fluid path integrity
- Supports cryogenic applications to -60°C

Specifications:

- **Materials:** Polypropylene, Tinted Polycarbonate
- **Sterilization:** Gamma radiation stable, EtO compatible, autoclavable to 121°C for up to 20 minutes
- **Testing:** Bioburden, Cytotoxicity, Extractables
- **RQC Series Tubing Sizes:** 1/4" (6.4 mm) and 3/8" (9.5 mm) tubing IDs
- **RQX Series Tubing Sizes:** 3/8" (9.5 mm) and 1/2" (12.7 mm) tubing IDs

RQC SERIES:

Quick Connects

RQCF655 (-9024 -001)

RQCF655 (-6005 -001)

Female Open Flow, 600 Series Barb, 1/4" (6.4 mm) Tubing ID



RQCFL655 (-9024 -001)

RQCFL655 (-6005 -001)

Female Open Flow, 600 Series Barb, 1/4" (6.4 mm) Tubing ID, Locking Feature



RQCM655 (-9024 -001) Platinum-Cured Silicone O-Ring

RQCM655 (-6005 -001) Platinum-Cured Silicone O-Ring

Male Open Flow, 600 Series Barb, 1/4" (6.4 mm) Tubing ID



RQCF670 (-9024 -001)

RQCF670 (-6005 -001)

Female Open Flow, 600 Series Barb, 3/8" (9.5 mm) Tubing ID



RQCFL670 (-9024 -001)

RQCFL670 (-6005 -001)

Female Open Flow, 600 Series Barb, 3/8" (9.5 mm) Tubing ID, Locking Feature



RQCM670 (-9024 -001) Platinum-Cured Silicone O-Ring

RQCM670 (-6005 -001) Platinum-Cured Silicone O-Ring

Male Open Flow, 600 Series Barb, 3/8" (9.5 mm) Tubing ID



RQCFC (-9024 -001)

RQCFC (-6005 -001)

Female Cap



RQCFLC (-9024 -001)

RQCFLC (-6005 -001)

Female Cap, Locking Feature



RQCMP (-9024 -001) Platinum-Cured Silicone O-Ring

RQCMP (-6005 -001) Platinum-Cured Silicone O-Ring

Male Plug



RQXF670 (-9024 -001)
RQXF670 (-6005 -001)

Female Open Flow, 600 Series Barb, 3/8" (9.5 mm) Tubing ID



RQXF680 (-9024 -001)
RQXF680 (-6005 -001)

Female Open Flow, 600 Series Barb, 1/2" (12.7 mm) Tubing ID



RQXFL670 (-9024 -001)
RQXFL670 (-6005 -001)

Female Open Flow, 600 Series Barb, 3/8" (9.5 mm) Tubing ID, Locking Feature



RQXFL680 (-9024 -001)
RQXFL680 (-6005 -001)

Female Open Flow, 600 Series Barb, 1/2" (12.7 mm) Tubing ID, Locking Feature



RQXM670 (-9024 -001) Platinum-Cured Silicone O-Ring
RQXM670 (-6005 -001) Platinum-Cured Silicone O-Ring

Male Open Flow, 600 Series Barb, 3/8" (9.5 mm) Tubing ID



RQXM680 (-9024 -001) Platinum-Cured Silicone O-Ring
RQXM680 (-6005 -001) Platinum-Cured Silicone O-Ring

Male Open Flow, 600 Series Barb, 1/2" (12.7 mm) Tubing ID



RQXFC (-9024 -001)
RQXFC (-6005 -001)

Female Cap



RQXFLC (-9024 -001)
RQXFLC (-6005 -001)

Female Cap, Locking Feature



RQXMP (-9024 -001) Platinum-Cured Silicone O-Ring
RQXMP (-6005 -001) Platinum-Cured Silicone O-Ring

Male Plug



Need Samples for Evaluation?

You can call to request most of our standard product in quantities of 5, or less, for free application evaluation.

+1 (970) 267-5200 Toll Free: (888) 404-5837

SBL Series

QUICK CONNECTS

Quick Connects

The SBL Series connector system is so intuitive that users just automatically know how to operate it the minute they pick it up. SBL Series quick connect fittings are cost effective and designed to meet your needs for a reusable component for small-bore applications in all fluid delivery areas. The SBL Series range is available in nylon, in two contrasting colors and fits 1/8" (3.2 mm) and 3/16" (4.8 mm) ID tubing for in-line applications.

SBL SERIES:
Female Open Flow

SBLF013 (-1 -2 -8B -CM030)
Side Latch Quick Connect Female 500 Series Barb, 1/8" (3.2 mm) Tubing ID



SBLF035 (-1 -2 -8B -CM030)
Side Latch Quick Connect Female 500 Series Barb, 3/16" (4.8 mm) Tubing ID



SBL SERIES:
Male Open Flow

SBLM013 (-001 -002 -004 -005) Nylon, Buna-N O-Ring
Side Latch Quick Connect Male 500 Series Barb, 1/8" (3.2 mm) Tubing ID

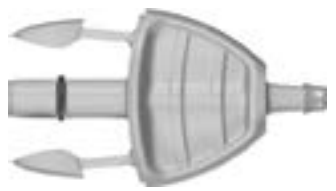

-001 Gray Nylon
-002 Blue Nylon

SBLM035 (-001 -002 -004 -005) Nylon, Buna-N O-Ring
Side Latch Quick Connect Male 500 Series Barb, 3/16" (4.8 mm) Tubing ID



-001 Gray Nylon
-002 Blue Nylon

SBLMFGB013 (-001)
Bag of 50 Side Latch Quick Connect Male and Female Sets, 500 Series Barb 1/8" (3.2 mm) Tubing ID, Grey Male and Blue Female Nylon



SBLMFBG013 (-002)
Bag of 50 Side Latch Quick Connect Male and Female Sets, 500 Series Barb 1/8" (3.2 mm) Tubing ID, Blue Male and Grey Female Nylon



SBLMFGB035 (-003)
Bag of 50 Side Latch Quick Connect Male and Female Sets, 500 Series Barb 3/16" (4.8 mm) Tubing ID, Grey Male and Blue Female Nylon



SBLMFBG035 (-004)
Bag of 50 Side Latch Quick Connect Male and Female Sets, 500 Series Barb 3/16" (4.8 mm) Tubing ID, Blue Male and Grey Female Nylon



Need it Fast?
You can order any of our 4,000+ parts online now with no order \$ minimums, 24 hours a day, 7 days a week!
www.nordsonmedical.com

XQ SERIES:
Female Valved Straight

XQSeries

Quick Connects

The XQ Series fittings, available in open flow and with integral shutoff valves, bring performance, convenience and utility to your tubing applications. XQ Series products fit 1/4" (6.4 mm), 5/16" (7.9 mm) and 3/8" ID (9.5 mm) tubing and are produced in acetal and polypropylene in five basic configurations – in-line male, in-line female, male panel mount, female panel mount and elbow. For versatility, durable XQ Series couplings interchange with other plastic and metal button-type couplings. Bring performance and service to your tubing applications by specifying XQ Series quick connects.

QUICK CONNECTS

XQSVF755 (-1006-B -1007-B -6006-EP)
XQ Series Female Valved Connector, 700 Series Barb, 1/4" (6.4 mm) Tubing ID



XQSVF765 (-1006-B -1007-B)
XQ Series Female Valved Connector, 700 Series Barb, 5/16" (8.0 mm) Tubing ID



XQSVF770 (-1006-B -1007-B -6006-EP)
XQ Series Female Valved Connector, 700 Series Barb, 3/8" (9.5 mm) Tubing ID



XQ SERIES:
Female Open Flow Straight

XQSF755 (-1006)
XQ Series Female Open Flow Connector, 700 Series Barb, 1/4" (6.4 mm) Tubing ID



XQSF770 (-1006 -1007)
XQ Series Female Open Flow Connector, 700 Series Barb, 3/8" (9.5 mm) Tubing ID



XQ SERIES:
Female Open Flow Panel Mount

XQSBF755 (-1006)
XQ Series Female Open Flow Panel Mount Connector with 11/16-24 UNEF Thread, 700 Series Barb, 1/4" (6.4 mm) Tubing ID, Nickel-Plated Brass Hex Nut (included)



XQSBF770 (-1006)
XQ Series Female Open Flow Panel Mount Connector with 11/16-24 UNEF Thread, 700 Series Barb, 3/8" (9.5 mm) Tubing ID, Nickel-Plated Brass Hex Nut (included)



Did You Know?

Nordson MEDICAL has an interactive PDF available online at www.nordsonmedical.com. Access part drawings, reference charts, data sheets, and more from just one location!

XQ SERIES:
Female Valved Panel Mount

XQSVBF755 (-1006-B)
XQ Series Female Valved Panel Mount Connector with 11/16-24 UNEF Thread, 700 Series Barb, 1/4" (6.4 mm) Tubing ID, Nickel-Plated Brass Hex Nut (included)



QUICK CONNECTS

XQSVBF770 (-1006-B)
XQ Series Female Valved Panel Mount Connector with 11/16-24 UNEF Thread, 700 Series Barb, 3/8" (9.5 mm) Tubing ID, Nickel-Plated Brass Hex Nut (included)



XQ SERIES:
Male Open Flow Straight

XQCM755 (-1006-B)
XQ Series Male Open Flow Connector, 700 Series Barb, 1/4" (6.4 mm) Tubing ID

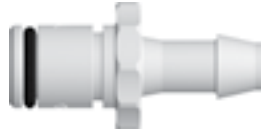

XQCM770 (-1006-B)
XQ Series Male Open Flow Connector, 700 Series Barb, 3/8" (9.5 mm) Tubing ID

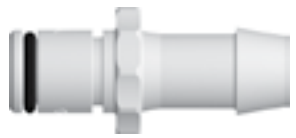

XQ SERIES:
Male Valved Straight

XQCVM755 (-1006-B -6006-EP)
XQ Series Male Valved Connector, 700 Series Barb, 1/4" (6.4 mm) Tubing ID



XQCVM765 (-1006-B -1007-B)
XQ Series Male Valved Connector, 700 Series Barb, 5/16" (7.9 mm) Tubing ID



XQCVM770 (-1006-B -1007-B -6006-EP)
XQ Series Male Valved Connector, 700 Series Barb, 3/8" (9.5 mm) Tubing ID



Looking for Something Different?

Most of our best product ideas have come from you, our customers. While we pride ourselves on our extensive product offering, we recognize that your needs are ever-changing and that our products, too, must adapt to your needs.

If there's a new product you think Nordson MEDICAL should make, please send us an Email at **designcenter@nordsonmedical.com** describing your product concept in as much detail as you desire. We will contact you with any questions, and who knows - the next catalog edition could include products YOU told us to build.

See page 14 for more information on the Design Center!

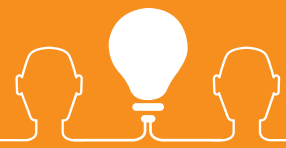

Need More Details?

Check out the Design Center Datasheet at **www.nordsonmedical.com** or contact Sales at **sales@nordsonmedical.com**.

XQ SERIES:

Male Open Flow Panel Mount

XQCBM755 (-1006-B)

XQ Series Male Open Flow Panel Mount Connector with 11/16-24 UNEF Thread, 700 Series Barb, 1/4" (6.4 mm) Tubing ID, Nickel-Plated Brass Hex Nut (included)



XQCBM770 (-1006-B)

XQ Series Male Open Flow Panel Mount Connector with 11/16-24 UNEF Thread, 700 Series Barb, 3/8" (9.5 mm) Tubing ID, Nickel-Plated Brass Hex Nut (included)

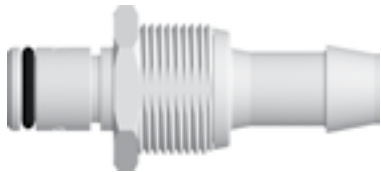

XQ SERIES:

Male Valved Panel Mount

XQCVBM755 (-1006-B)

XQ Series Male Valved Panel Mount Connector with 11/16-24 UNEF Thread, 700 Series Barb, 1/4" (6.4 mm) Tubing ID, Nickel-Plated Brass Hex Nut (included)



XQCVBM770 (-1006-B)

XQ Series Male Valved Panel Mount Connector with 11/16-24 UNEF Thread, 700 Series Barb, 3/8" (9.5 mm) Tubing ID, Nickel-Plated Brass Hex Nut (included)



XQ SERIES:

Male Open Flow Elbow

XQCLM755 (-1006-B)

XQ Series Male Open Flow Elbow Connector, 700 Series Barb, 1/4" (6.4 mm) Tubing ID



XQCLM770 (-1006-B)

XQ Series Male Open Flow Elbow Connector, 700 Series Barb, 3/8" (9.5 mm) Tubing ID

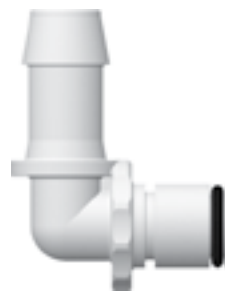

XQ SERIES:

Male Valved Elbow

XQCVM755 (-1006-B)

XQ Series Elbow Male Valved Connector, 700 Series Barbs, 1/4" (6.4 mm) Tubing ID



XQ SERIES:

Panel Mount Nut

PM4N (Nickel-Plated Brass)

XQ Series 11/16-24 UNEF Panel Mount Nut



Need Samples for Evaluation?

You can call to request most of our standard product in quantities of 5, or less, for free application evaluation.

+1 (970) 267-5200 Toll Free: (888) 404-5837

CHECK

Valves

Anti-Siphon Check Valves
PG-30



High Flow Check Valve
PG-31



One-Way Check Valves
PG-31

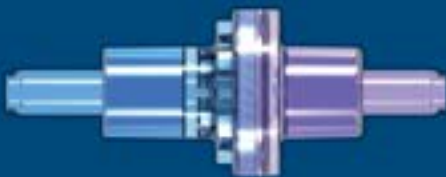

Barbed Check Valves
PG-32



Double Check Valves
PG-33



SCV Series

Check Valves

SCV Series products are available in barbed, anti-siphon or one-way check valve configurations in a variety of materials and end fittings. Barbed check valves reduce the risk of contamination and feature more precise, lower crack pressures and higher flow rates. They are ideal for medical device designers focused on infusion, drainage and irrigation applications. All the valves feature a low priming volume, ease of removing air bubbles during priming and operate in any spatial orientation. All materials of construction satisfy USP Class VI and ISO 10993 criteria.

Features & Benefits:

- Materials meet USP Class VI and ISO 10993 criteria
- DEHP- and latex-free silicone diaphragms
- All products are suitable for EtO or gamma sterilization
- Several connection configurations and materials
- Air bubbles completely removable during priming
- Operate in any spatial orientation
- Normally closed valve positioning for optimum flow control
- Available with the lowest cracking pressure on the market
- Air entrapment readily alleviated during priming

SCV SERIES:

Anti-Siphon Check Valves

SCV06018 (Clear and White MABS w/Silicone Diaphragm)

Check Valve, Socket Fitment for 0.095" (2.4 mm) OD Tubing



Cracking Pressure: \leq .100 psig
Max. Back Pressure: 116 psig
Flow Rate: \geq 110 ml/min
Flow Direction: Left to right

SCV06308 (Clear Transparent Polycarbonate and Green Polycarbonate w/Silicone Diaphragm)

Check Valve, Female Locking Luer to Pocket for .098" (2.5 mm) OD Tubing



Cracking Pressure: 2.9 +/- 0.725 psig
Max. Back Pressure: 304.5 psig
Flow Rate with Glucose: \geq 150 ml/min
Flow Direction: Left to right

SCV06335 (Transparent Polycarbonate and White Polycarbonate w/Silicone Diaphragm)

Check Valve, Female Locking Luer to Pocket for .118" (3.0 mm) OD Tubing



Cracking Pressure: 2.9 +/- 0.725 psig
Max. Back Pressure: 304.5 psig
Flow Rate: \geq 150 ml/min
Flow Direction: Left to right

SCV SERIES:
Anti-Siphon Check Valves

SCV06246 (Clear Transparent MABS and Blue Transparent SAN w/Silicone Diaphragm)

Check Valve, Pocket for .122" (3.1 mm) OD Tubing to Male Locking Luer



Cracking Pressure: 2.9 +/- 0.725 psig
Max. Back Pressure: 304.5 psig
Flow Rate: ≥ 150 ml/min
Flow Direction: Left to right

SCV06248 (Blue SAN and Clear MABS w/Silicone Diaphragm)

Check Valve, Pocket for .161" (4.0 mm) OD Tubing to Male Locking Luer



Cracking Pressure: 2.176-3.626 psig
Max. Back Pressure: 304.579 psig
max 30 sec.
Flow Rate: 170 ml/min
Flow Direction: Left to right

SCV06264 (Clear and Blue MABS w/Silicone Diaphragm)

Check Valve, Pocket for .161" (4.0 mm) OD Tubing to .161" (4.0 mm) OD Tubing



Cracking Pressure: 1.450-4.351 psig
Max. Back Pressure: 304.579 psig
Flow Rate: max 200 ml/min
Flow Direction: Left to right

SCV06272 (Transparent SAN and Blue Transparent MABS w/Silicone Diaphragm)

Check Valve, Pocket for .161" (4.1 mm) OD Tubing to Female Locking Luer



Cracking Pressure: 2.9 +/- 0.725 psig
Max. Back Pressure: 304.5 psig
Flow Rate: ≥ 150 ml/min
Flow Direction: Left to right

SCV06249 (Blue Transparent and Transparent MABS w/Silicone Diaphragm)

Check Valve, Pocket for .165" (4.2 mm) OD Tubing to Male Locking Luer



Cracking Pressure: 2.9 +/- 0.725 psig
Max. Back Pressure: 304.5 psig
Flow Rate: ≥ 150 ml/min
Flow Direction: Left to right

SCV06329 (Clear and Blue SAN w/Silicone Diaphragm)

Check Valve, Female Locking Luer Linden



Cracking Pressure: 1.450-4.351 psig
Max. Back Pressure: 304.579 psig
max 30 sec.
Flow Rate: 200 ml/min
Flow Direction: Left to right

SCV06252 (Clear Transparent SAN and Blue Transparent SAN w/Silicone Diaphragm)

Check Valve, Female Locking Luer to Male Locking Luer



Cracking Pressure: 2.9 +/- 0.725 psig
Max. Back Pressure: 304.5 psig
Flow Rate with Glucose: ≥ 150 ml/min
Flow Direction: Left to right

SCV06352 (Clear MABS w/Silicone Diaphragm)

High Flow Check Valve, Pocket for .346" (8.8 mm negative) OD Tubing to Pocket for .346" (8.8 mm negative) OD Tubing



Cracking Pressure: ≤ .290 psig
Max. Back Pressure: 14,500 psig
Flow Rate: ≥ 1000 ml/min
Flow Direction: Left to right

SCV SERIES:
One-Way Check Valves

SCV08053 (White SAN w/Silicone Diaphragm w/Natural LDPE)

Check Valve, Female Locking Luer to Male Locking Luer w/Cap



Cracking Pressure: ≤ .174 psig
Max. Back Pressure: 87.023 psig
Flow Rate: ≥ 90 ml/min
Flow Direction: Left to right

SCV10090 (Clear Polycarbonate w/Silicone Diaphragm)

Check Valve, Female Locking Luer to Pocket for .118" (3.0 mm) OD Tubing



Cracking Pressure: ≤ .174 psig
Max. Back Pressure: 87.023 psig
Flow Rate: ≥ 90 ml/min
Flow Direction: Left to right

SCV17090 (Clear Polycarbonate w/Silicone Diaphragm)

Check Valve, Female Locking Luer to Socket for .118" (3.0 mm) ID x .161" (4.1 mm) OD Tubing



Cracking Pressure: ≤ .174 psig
Max. Back Pressure: 87.023 psig
Flow Rate: ≥ 90 ml/min
Flow Direction: Left to right

SCV21053 (Clear and White MABS w/Silicone Diaphragm)

Check Valve, Socket for .118" (3.0 mm) ID x .161" (4.1 mm) OD Tubing x 2



Cracking Pressure: ≤ .174 psig
Max. Back Pressure: 87.023 psig
Flow Rate: ≥ 90 ml/min
Flow Direction: Left to right

SCV22050 (Clear SAN and Clear MABS w/Silicone Diaphragm)

Check Valve, Socket for .118" (3.0 mm) ID x .161" (4.1 mm) OD to Male Locking Luer



Cracking Pressure: ≤ .174 psig
Max. Back Pressure: 87.023 psig
Flow Rate: ≥ 90 ml/min
Flow Direction: Left to right

SCV06265 (Blue and Clear Polycarbonate w/Silicone Diaphragm)

Check Valve, Autoclavable, Socket for .122" (3.1 mm) ID x .165" (4.2 mm) OD Tubing x 2



Cracking Pressure: ≤ .087 psig
Max. Back Pressure: 87.023 psig
Flow Rate: ≥ 150 ml/min
Flow Direction: Left to right

CHECK VALVES

SCV SERIES: One-Way Check Valves

SCV23050 (Clear SAN w/Silicone Diaphragm)

Check Valve, Female Locking Luer to Male Locking Luer



Cracking Pressure: ≤ .174 psig
Max. Back Pressure: 87.023 psig
Flow Rate: ≥ 90 ml/min
Flow Direction: Left to right

SCV25052 (Clear MABS and Blue SAN w/Silicone Diaphragm)

Air Pressure Relief Valve, Stem for .157" (4.0 mm) ID Tubing to Stem for .118" (3.0 mm) ID Tubing



Cracking Pressure: ≤ .174 psig
Max. Back Pressure: 87.023 psig
Flow Rate: ≥ 90 ml/min
Flow Direction: Left to right

VPS5401068N (Polycarbonate with Silicone Disk)

Check Valve, Male/Female Luer, 420 mL/min Flow Rate at 1 M Head 30 psi Back Pressure, 1/4 psi Inlet Cracking Pressure



VPS5401020N (Polycarbonate with Silicone Disk)

Check Valve, Male/Female Luer, 129 mL/min Flow Rate at 100 mmHg, 45 psi Back Pressure, 1-5 psi Inlet Cracking Pressure



VPS5401036SN (Polycarbonate with Silicone Disk)

Reflux Check Valve, Male/Female Luer, 350 mL/min Flow Rate at 1 M Head, 45 psi Back Pressure, Opens at 284 mmHg



VPS5401001N (ABS Housing with Silicone Disk)

Check Valve, Male Slip Luer, 420 mL/min Flow Rate at 1M Head, 30 psi Back Pressure, 1/4 psi Inlet Cracking Pressure



SCV SERIES: Barbed Check Valves

SCV67220 (MABS w/Silicone Diaphragm)

Check Valve, Socket for 3/32" (2.4 mm) x 3/32" (2.4 mm) ID Tubing



Cracking Pressure: ≤ .087 psig
Max. Back Pressure: 116.030 psig
Flow Rate: ≥ 150 ml/min
Flow Direction: Left to right

SCV67220/230 (MABS w/Silicone Diaphragm)

Check Valve, Socket for 3/32" (2.4 mm) x 1/8" (3.2 mm) ID Tubing



Cracking Pressure: ≤ .087 psig
Max. Back Pressure: 116.030 psig
Flow Rate: ≥ 150 ml/min
Flow Direction: Left to right

SCV67FL/220 (SAN and MABS w/Silicone Diaphragm)

Check Valve, Female Locking Luer to Barb for 3/32" (2.4 mm) ID Tubing



Cracking Pressure: ≤ .087 psig
Max. Back Pressure: 116.030 psig
Flow Rate: ≥ 150 ml/min
Flow Direction: Left to right

SCV67220/ML (SAN and MABS w/Silicone Diaphragm)

Check Valve, Socket for 3/32" (2.4 mm) ID Tubing to Male Locking Luer



Cracking Pressure: ≤ .087 psig
Max. Back Pressure: 116.030 psig
Flow Rate: ≥ 150 ml/min
Flow Direction: Left to right

SCV67230/220 (MABS w/Silicone Diaphragm)

Check Valve, Socket for 1/8" (3.2 mm) x 3/32" (2.4 mm) ID Tubing



Cracking Pressure: ≤ .087 psig
Max. Back Pressure: 116.030 psig
Flow Rate: ≥ 150 ml/min
Flow Direction: Left to right

SCV67230 (MABS w/Silicone Diaphragm)

Check Valve, Socket for 1/8" (3.2 mm) x 1/8" (3.2 mm) ID Tubing



Cracking Pressure: ≤ .087 psig
Max. Back Pressure: 116.030 psig
Flow Rate: ≥ 150 ml/min
Flow Direction: Left to right

SCV67FL/230 (SAN and MABS w/Silicone Diaphragm)

Check Valve, Female Locking Luer to Barb for 1/8" (3.2 mm) ID Tubing



Cracking Pressure: ≤ .087 psig
Max. Back Pressure: 116.030 psig
Flow Rate: ≥ 150 ml/min
Flow Direction: Left to right

SCV67230/ML (SAN and MABS w/Silicone Diaphragm)

Check Valve, Socket for 1/8" (3.2 mm) ID Tubing to Male Locking Luer



Cracking Pressure: ≤ .087 psig
Max. Back Pressure: 116.030 psig
Flow Rate: ≥ 150 ml/min
Flow Direction: Left to right

CHECK VALVES

DCV SERIES:

Double Check Valves, Tubing Pocket Chimney Port

DCV114 (-001) Radiation-Stable Polycarbonate

Double Check Valve, Tubing Pocket Chimney Port

Cracking Pressure: 2-5 psi



DCV115 (-001) Radiation-Stable Polycarbonate

Double Check Valve, Tubing Pocket Chimney Port, Rotating Luer Lock Exit Port

Cracking Pressure: 2-5 psi



DCV SERIES:

Double Check Valves, Female Luer Chimney Port

DCV118 (-001) Radiation-Stable Polycarbonate

Double Check Valve, Female Luer Chimney Port

Cracking Pressure: 2-5 psi



DCV125 (-001) Radiation-Stable Polycarbonate

Double Check Valve, Female Luer Chimney Port, Rotating Luer Lock Exit Port

Cracking Pressure: 2-5 psi



DCV Series

Check Valves

Nordson MEDICAL's unique DCV Series bi-directional double check valve is designed to transfer clean fluid from a supply vessel to a use site. The fluid supply vessel is connected to the valve supply port (chimney) using a luer connection or tubing. The fluid is withdrawn from the supply vessel by a syringe or other device connected to the aspiration port. When the syringe is compressed the fluid is then transferred, through the exit port, to the use site without adulterating the fluid. DCV Series bi-directional valves are produced in polycarbonate resin using a silicone diaphragm, with two available inlet ports connecting to the female luer aspiration and male luer discharge ports.

Features & Benefits:

- Bi-directional double check valve
- No need for disconnection to fill syringe
- Satisfies USP Class VI criteria
- Low cracking pressure
- Clean fluid transfer from supply to site
- High flow rate

Step 1: Clean fluid drawn into syringe

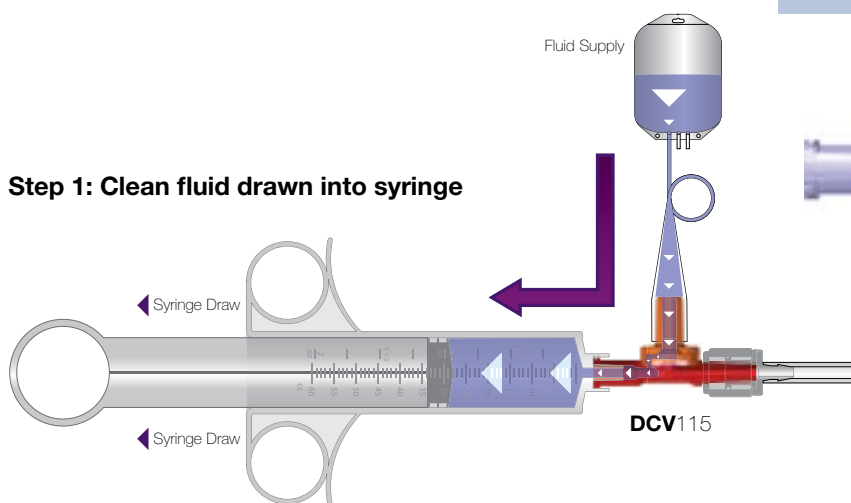

Step 2: Clean fluid expelled to use site

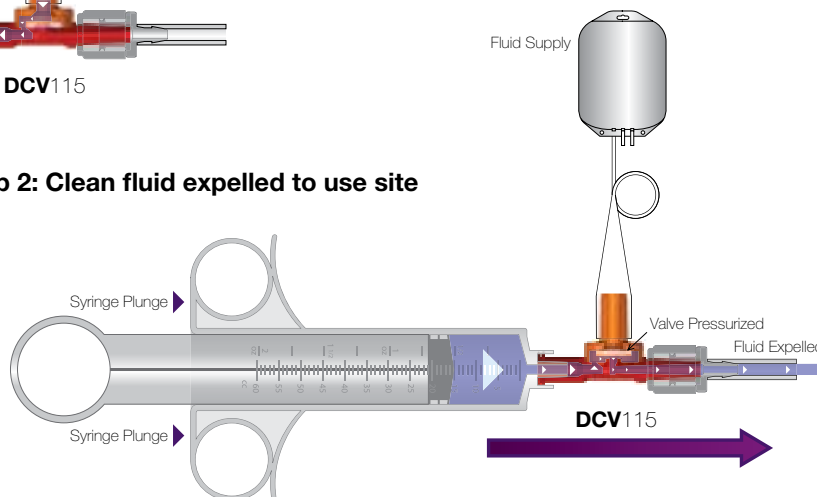

NEEDLEFREE

Swabable Valves



Swabable Straight Valves
PG-34



Swabable 'Y' Valves
PG-35



Bondable Valve
PG-35



Swabable Bag Valve
PG-35



Swabable Break-Off Valves
PG-35



Tube End Valves
PG-35



13 mm Swabable Vial Cap
PG-35



20 mm Swabable Vial Cap
PG-35



Swabable T-Port Valve
PG-35



4-Way Swabable Stopcock
PG-35



NV Series

Needlefree Swabable Valves

Nordson MEDICAL now offers cost efficient needlefree swabable valves featuring higher flow rates, low priming volumes, and a straight through design for unobstructed flow. The valves don't require caps, and the septum surface can be easily disinfected. Designed for the injection and aspiration of fluids, particularly for IV applications, cardiology, and catheters, the hermetic septum seal reduces the risk of biofilm formation and contamination. Available in widely used polycarbonate and copolyester materials, these valves are compatible with all industry standard luer syringes and connects, validating them as an efficient component solution for the OEM market.

Features & Benefits:

- Valve stems and bodies securely mate with all standard luer syringes and connectors
- Several configurations that are easy to customize
- Normally closed system to reduce the risk of infection
- Low priming volume and high flow rates
- Straight through design for unobstructed flow
- Gamma radiation stable and EtO compatible
- Not made with natural rubber latex or DEHP

The NV Series products are shipped bulk, non-sterile and are single patient use medical device components requiring further processing (e.g. assembly, packaging, sterilization) before clinical use. The buyer is responsible for determining effects of processing/multiple usage on these components, appropriateness of the component in the final application, and pre/post shelf life.

NVFMLLCP (Copolyester)

Swabable Straight Valve, Female Luer to Male Luer Lock



NVFMLLPC (Polycarbonate)

Swabable Straight Valve, Female Luer to Male Luer Lock



NV SERIES:
Needlefree Swabable Valves

NV FY36PC (Polycarbonate)

Swabable Y Valve, Female Luer Y Port to 3.6 mm Tube Sockets



NV FY401CP (Copolyester)

Swabable Y Valve, Female Luer Y Port to 4.01 mm Tube Sockets



NV FY401PC (Polycarbonate)

Swabable Y Valve, Female Luer Y Port to 4.01 mm Tube Sockets



NV FMLPC (Polycarbonate)

Bondable Valve, Female Luer to Male Luer Slip



NV FBGPC (Polycarbonate)

Swabable Bag Valve, Female Luer to Bag Access Port



NV FBV60PC (Polycarbonate)

Swabable Break-Off Valve, Female Luer to Break Off 6.0 mm Port



NV FBV66PC (Polycarbonate)

Swabable Break-Off Valve, Female Luer to Break Off 6.6 mm Port



NV F20PC (Polycarbonate)

Tube End Valve, Female Luer to 2.0 mm Tube Socket



NV F25PC (Polycarbonate)

Tube End Valve, Female Luer to 2.5 mm Tube Socket



NV F28PC (Polycarbonate)

Tube End Valve, Female Luer to 2.8 mm Tube Socket



NV F37PC (Polycarbonate)

Tube End Valve, Female Luer to 3.7 mm Tube Socket



NV F41PC (Polycarbonate)

Tube End Valve, Female Luer to 4.1 mm Tube Socket



NV F13VPC (Polycarbonate)

13 mm Swabable Vial Cap, Female Luer to 13 mm Vial Cap



NV F20VPC (Polycarbonate)

20 mm Swabable Vial Cap, Female Luer to 20 mm Vial Cap



NV FTPC (Polycarbonate)

Swabable T-Port Valve, Female Luer T Port to 4.1 mm Tube Sockets



NV FSCMLLPC (Polycarbonate)

4-Way Lever Swabable Stopcock, Female Luer Stopcock to Male Luer Lock



NEEDLEFREE
VALVES

STOPCOCK

FITTINGS

1-Way Stopcocks PG-36



3-Way Stopcocks PG-37



4-Way Stopcocks PG-37



FC Series Stopcocks

FC Series stopcocks are designed to easily control the flow of a liquid or gas through the use of an on/off diverter, and are available in three basic configurations – 1-way, 3-way, and 4-way. These chemically resistant stopcocks bring efficiency, convenience, and practicality to your tubing applications and are 510(k) cleared.

Features & Benefits:

- 1-way, 3-way, and 4-way configurations
- Chemically resistant
- 510(k) cleared
- Not made with DEHP
- Diverter arrows provide a clear indication of flow
- Custom solutions available, including manifolds, ganged manifolds, and tubing assemblies
- Standard flow and high flow options
- Polycarbonate, PEI, nylon, and HDPE materials

FC SERIES: 1-Way Stopcocks

FCA021 (-001)

1-Way, Female Luer to Threaded Post, High Pressure



FCFM (-001)

1-Way, Female Luer to Male Luer



FCFMR (-001)

1-Way, Female Luer to Male Luer with Luer Lock Ring



VPB1000050N (Polycarbonate Body with Polyethylene Handle)

One Way Stopcock, Capped Male Luer Lock to Capped Female Luer Thread Style



FC SERIES:

1-Way Stopcocks

VPB1000055N (Polycarbonate Body with Polyethylene Handle)

One way Stopcock, Male Slip Luer to Capped Female Luer Thread Style



FC SERIES:

3-Way Stopcocks

FCLBFFMR-1A (-003)

3-Way, Female Luer to Female Luer to Male Luer with Luer Lock Ring, Large Bore



VPB1000079N (Polycarbonate Body with Polyethylene Handle)

Three Way Stopcock, (2) Capped Female Luer Thread Style and Capped Male Luer Lock



VPB1000062N (Polycarbonate Body with Polyethylene Handle)

Three Way Stopcock, (2) Female Luer Thread Style and Male Slip Luer



FC SERIES:

4-Way Stopcocks

VPB1000099N (Polycarbonate Body with Polyethylene Handle)

Four Way Stopcock, (2) Capped Female Luer Thread Style and Male Slip Luer



VPB1000110N (Polycarbonate Body with Polyethylene Handle)

Four Way Stopcock, (2) Capped Female Luer Thread Style & Capped Male Luer Lock



FC SERIES:

3-Way Stopcocks

FCFFM (-010)

3-Way, Female Luer to Female Luer to Male Luer



FCFFMR (-003)

3-Way, Female Luer to Female Luer to Male Luer with Luer Lock Ring

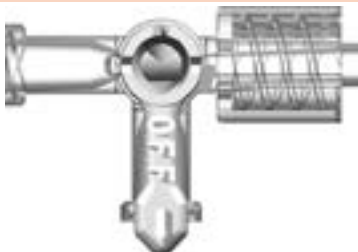

FCHPFFMR (-001)

3-Way, Female Luer to Female Luer to Male Luer with Luer Lock Ring, High Pressure



FCLBFFM (-001, -003)

3-Way, Female Luer to Female Luer to Male Luer, Large Bore



FCLBFFM-1A (-003)

3-Way, Female Luer to Female Luer to Male Luer, Large Bore, Radiation Stable



STOPCOCK FITTINGS

BIOPROCESS

Fittings



Bag Ports
PG-38



Opposing Barb Ports
PG-41



BioClamp®
PG-42



BioValve®
PG-43



Gaskets
PG-44



PharmaLok™ Clamps
PG-45



RQC Series Quick Connects
PG-48



RQX Series Quick Connects
PG-49



Sanitary Fittings
PG-50



Large Tube-to-Tube
PG-52



BAG Ports

Nordson MEDICAL's new high tech series of bag ports offers a variety of benefits new to the biopharmaceutical industry through a unique design. Value Pharma™ resin holds credentials that many manufacturers deem fundamental, such as animal derivative free qualification, USP Class VI certification, and the guarantee of heat sealing and conformance with polyethylene bags. The resin then goes even further to provide a strong, 24-hour resistance to alcohol stress cracking. RENOLIT SOLMED Granuflex 4301 resin demonstrates lower leachable levels and high purity.

Their unique design sets these new ports apart from existing solutions. They not only conform with frequently utilized tubing sizes from 1/8" (3.2 mm) to 3" (76.2 mm), but they are also designed to ASME and BPE ferrule specifications, allowing them to work with leading industry fittings, filters and other devices. However, the most notable of the bag ports' specifications are those that are new to the industry – the parabolic lead and the alignment ribs. These two features, respectively, reduce the amount of time it takes to drain a bag by 24 percent and improve flow dynamics through the port.

Features & Benefits:

Compliant to ASME BPE Ferrule Specification

- Works with leading industry single-use bags
- **Barb Sizes Consist of Range From 1/8" (3.2 mm) to 1" (25.4 mm) and Ferrule TC Style**

- Works with the frequently utilized tubing sizes found in the pharmaceutical industry

Parabolic Lead

- Reduces the time it takes to drain a bag by 17 to 24%
- Similar results for both fluid and powder applications

Alignment Ribs

- Improves fluid dynamics of flow through the port

Value Pharma™ Resin

- Ensures heat sealing with polyethylene bags
- Includes a USP Class VI certification
- Animal derivative free
- Resistant to alcohol stress cracking

RENOLIT SOLMED Granuflex 4301 Resin

- Demonstrates lower leachable levels and high purity

BAG PORTS:

600 Series Barb Style

SFBP630 (-VP1) Value Pharma™ Resin

Bag Port with 600 Series Barb, 1/8" (3.2 mm) Tubing ID



BAG PORTS:

600 Series Barb Style

SFBP680 (-VP1 -CM056) Value Pharma™ Resin, Granuflex Polyethylene

Bag Port with 600 Series Barb, 1/2" (12.7 mm) Tubing ID



SFBP655 (-VP1 -CM056) Value Pharma™ Resin, Granuflex Polyethylene

Bag Port with 600 Series Barb, 1/4" (6.4 mm) Tubing ID



SFBP6100 (-VP1 -CM056) Value Pharma™ Resin, Granuflex Polyethylene

Bag Port with 600 Series Barb, 3/4" (19.0 mm) Tubing ID



SFBP670 (-VP1) Value Pharma™ Resin

Bag Port with 600 Series Barb, 3/8" (9.5 mm) Tubing ID



SFBP6110 (-VP1 -CM056) Value Pharma™ Resin, Granuflex Polyethylene

Bag Port with 600 Series Barb, 1" (25.4 mm) Tubing ID



BIOPROCESSING FITTINGS

Need More Details?
Check out all of our Bag Ports at www.bagports.com or contact Sales at bagports@nordsonmedical.com.

Need it Fast?
You can order any of our 4,000+ parts online now with no order \$ minimums, 24 hours a day, 7 days a week!
www.nordsonmedical.com

BAG PORTS:

Ferrule Fitting to 1-1/2" TC Connection

SFBPF1 (-VP1) Value Pharma™ Resin

Bag Port with Ferrule Fitting to 1-1/2" TC Connection



Innovative Parabolic Lead & Alignment Ribs

BAG PORTS:

3" TC Connection

SFBPF3 (-VP1) Value Pharma™ Resin

Bag Port with Ferrule Fitting to 3" TC Connection



BIOPROCESSING FITTINGS

Looking for Something Different?

Most of our best product ideas have come from you, our customers. While we pride ourselves on our extensive product offering, we recognize that your needs are ever-changing and that our products, too, must adapt to your needs.

If there's a new product you think Nordson MEDICAL should make, please send us an Email at designcenter@nordsonmedical.com describing your product concept in as much detail as you desire. We will contact you with any questions, and who knows - the next catalog edition could include products YOU told us to build.

See page 14 for more information on the Design Center!

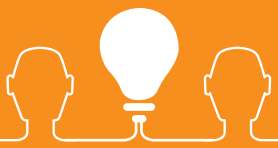

Part Drawings Online!

Nordson MEDICAL provides dimensional drawings available for download for all of its fittings. www.nordsonmedical.com

Need More Details?

Check out all of our bioprocessing components at www.bioprocesscomponents.com or contact Sales at sales@nordsonmedical.com.

OPPOSING

Barb Ports

Nordson MEDICAL now offers the biomedical market opposing barb ports. The larger ports can be used in filling applications, and they are also ideally suited to work with sensors.

Features & Benefits:

- Easy to heat seal into film material
- Can be used in filling applications
- Port plates featuring Value Pharma™ resin
- Works great with silicone and TPE style tubing
- Better tube retention
- 600 Series barb sizes
- Animal-free polyethylene
- Materials meet USP Class VI criteria and are ADF compliant
- Fits tubing sizes from 3/16" to 3/4"

OPPOSING BARB PORTS: 600 Series Barb Style

SFBP635-635 (-VP1) Value Pharma™ Resin

Dip Tube (Opposable Barbs) with Two 600 Series Barbs, 3/16" (4.8 mm) Tubing ID



SFBP655-655 (-VP1 -CM056) Value Pharma™ Resin, Granuflex Polyethylene

Dip Tube (Opposable Barbs) with Two 600 Series Barbs, 1/4" (6.4 mm) Tubing ID



SFBP670-670 (-VP1) Value Pharma™ Resin

Dip Tube (Opposable Barbs) with Two 600 Series Barbs, 3/8" (9.5 mm) Tubing ID



SFBP680-680 (-VP1) Value Pharma™ Resin

Dip Tube (Opposable Barbs) with Two 600 Series Barbs, 1/2" (12.7 mm) Tubing ID

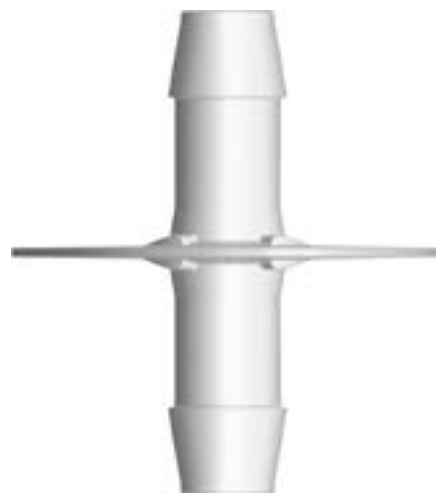

SFBP6100-6100 (-VP1) Value Pharma™ Resin

Dip Tube (Opposable Barbs) with Two 600 Series Barbs, 3/4" (19.0 mm) Tubing ID

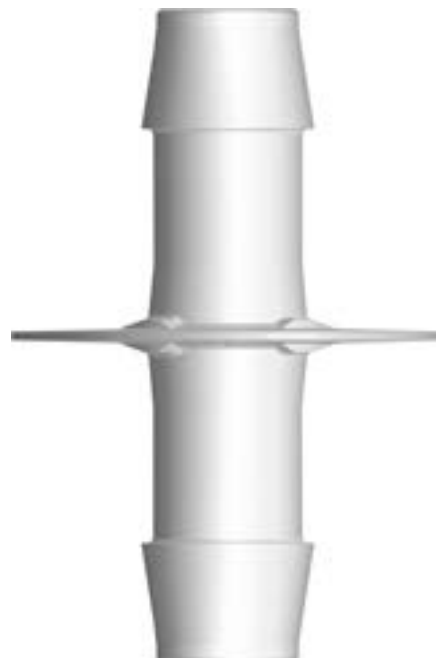

BIOClamp®

BioClamp® plastic quick-release clamps are specifically designed to meet the needs of busy pharmaceutical and bioprocessing laboratories, offering full flexibility in single-use applications. The clamps are specifically designed to work with Nordson MEDICAL's SF Series sanitary fitting Mini and Maxi flanges, related caps and gaskets, and in conjunction with OEM filters and bioprocessing bags. The clamp is lightweight and easy for technicians to install and provides for quick and convenient assembly release.

Features & Benefits:

- Can be SIP repeatedly
- Can be autoclaved repeatedly at 134°C for 5 minutes
- Can be subjected to 60 kiloGrays without weakening
- Reduced distortion on polymeric components
- More compatible with current manufacturing than steel
 - Greater flexibility in operation
 - Single-use disposal
- Applications
 - Bioprocessing
 - Single-use technology (SUS)
 - Drug discovery and development
 - Fluid transport
 - Pharmaceutical scale up
 - Sterile bag systems

Specifications:

Materials: Glass reinforced Nylon 66

Tubing Sizes: 1/2" to 1 1/2"

Max. Operating Pressure: 150 psig

Max. Cumulative Gamma Dose: 60 kiloGrays

USP Class VI Certified Materials



Reference part shown: VNG150WHT

Due to size we are not able to display all large BioClamp® fittings. Please see www.nordsonmedical.com for part reference. Minimum package quantities vary by tube IDs, please verify minimum package sizes when placing orders.

VNG075WHT (Glass Reinforced White Nylon)

Clamp, Mini Flange, 1/2" (12.7 mm) to 3/4" (19.0 mm)

VNG150WHT (Glass Reinforced White Nylon)

Clamp, Maxi Flange, 1" (25.4 mm) to 1.5" (38.1 mm)

VNG200WHT (Glass Reinforced White Nylon)

Clamp, Maxi Flange, 2" (50.8 mm)

VNG250WHT (Glass Reinforced White Nylon)

Clamp, Maxi Flange, 2.5" (63.5 mm)

VNG300WHT (Glass Reinforced White Nylon)

Clamp, Maxi Flange, 3" (76.2 mm)

VNG400WHT (Glass Reinforced White Nylon)

Clamp, Maxi Flange, 4" (101.6 mm)

VNG600WH (Glass Reinforced White Nylon)

Clamp, Maxi Flange, 6" (152.4 mm)

VNG800WH (Glass Reinforced White Nylon)

Clamp, Maxi Flange, 8" (203.2 mm)

Need it Fast?

You can order any of our 4,000+ parts online now with no order \$ minimums, 24 hours a day, 7 days a week!

www.nordsonmedical.com

Technical Assistance

Trying to choose the correct part? Need more material information than is published in this catalog? Call Nordson MEDICAL Technical Support **(970) 267-5200**.

BIOValve®

The BioValve® pinch valve is a precision restriction flow controller and shut-off valve for silicone tubing used in bioprocessing and pharmaceutical manufacturing applications.

Features & Benefits:

- Can be SIP repeatedly
- Can be autoclaved repeatedly at 134°C for 5 minutes
- Can be subjected to 60 kiloGrays without weakening
- Can be calibrated to minimize flow path turbulence
- Can be used with one hand
- Thread pitch is calibrated to 2mm per turn

Specifications:

Materials: Glass reinforced Nylon 66

Tubing Sizes: 1/4" to 1"

Max. Operating Pressure: 150 psig

Max. Cumulative Gamma Dose: 60 kiloGrays

USP Class VI Certified Materials

VBV0500NW (Glass Reinforced White Nylon)
Pinch Valve Mini, 1/4" (6.4 mm) to 1/2" (12.7 mm) Tubing OD

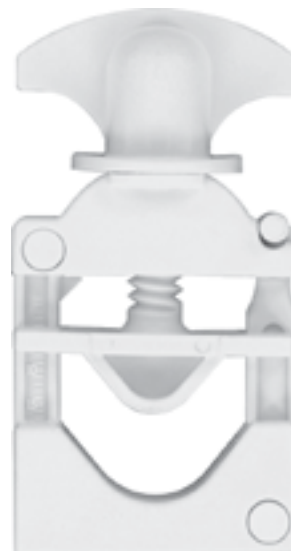

BIOPROCESSING
FITTINGS

VBV1000NW (Glass Reinforced White Nylon)
Pinch Valve, Maxi, 1/2" (12.7 mm) to 1" (25.4 mm)



Looking for Something Different?

Most of our best product ideas have come from you, our customers. While we pride ourselves on our extensive product offering, we recognize that your needs are ever-changing and that our products, too, must adapt to your needs.

If there's a new product you think Nordson MEDICAL should make, please send us an Email at designcenter@nordsonmedical.com describing your product concept in as much detail as you desire. We will contact you with any questions, and who knows - the next catalog edition could include products YOU told us to build.

See page 14 for more information on the Design Center!



GASKETS

Material options include Class VI compliant PTFE/EPDM and platinum-cured silicone in gasket sizes that fit both the 1-1/2" (Maxi) and the 3/4" (Mini) Flange Series. Keeping customer requirements in mind, these components were manufactured for applications requiring the highest sanitary standards and chemical purity.

GMN450 (-PX)

Molded Gasket for Mini Flange SFMN Series Fittings



G42MPGR-TF075 (-E)

Molded Tuf-Flex® Gasket for Mini Flange SFMN Series Fittings



GMX455 (-PX)

Molded Gasket for Maxi Flange SFMX Series Fittings



G40MPGR-TF150 (-E)

Molded Tuf-Flex® Gasket for Maxi Flange SFMX Series Fittings



G424TRX-0200 Platinum-Cured Silicone

Molded Gasket for 2" Flange Fittings



G424TRX-0300 Platinum-Cured Silicone

Molded Gasket for 3" Flange Fittings



Need More Details?

Check out all of our bioprocessing components at www.bioprocesscomponents.com or contact Sales at sales@nordsonmedical.com.

Custom Assembly

We produce standard components to fit your current assemblies and devices, but we also provide custom solutions by applying a variety of assembly options, such as joining fittings, connectors, filters, and other components to tubing. From systems using a single fitting to complex configurations utilizing various components, we can design complete assemblies to your requirements.

PHARMA^{Lok}[™]

Clamps

The biopharmaceutical industry has made a strong move towards single-use technology, so Nordson MEDICAL has developed ground-breaking clamp designs that simplify the assembly process by making it effortless to securely attach sanitary fittings to bag ports and filters.

Nordson MEDICAL's PharmaLok™ clamps are ASME BPE compliant and operate at a maximum pressure of 80 psi. Single-use and easy-open clamp sizes include .5" to .75" and 1" to 1.5", and the tube clamp supports tubing sizes from .5" to 1.25".

Pharmalok clamps provide a significant advancement for the industry, as a number of existing solutions either require tools for closure or consist of multiple components, which turns what should be a simple operation into a difficult and awkward process.

Easily operated with one hand, PharmaLok's patented design allows effortless attachment of fittings to bag ports and filters. The user simply rests the fitting in the PharmaLok's regulation-sized slot, lightly grips the surrounding handles, and listens for the sound of clicks to confirm a secure connection.

Single-Use Clamps & Easy-Open Clamps

Features & Benefits:

- ASME BPE 2014 DT-9.3.1 compliant
- DIN compliant
- Easy to use, one-handed closure - no tools needed
- Tamper evident and zip tie compatible
- 360° compression
- Connects both plastic and stainless steel fittings
- SIP/CIP compatible

Specifications:

Materials: USP Class VI & ISO 11137 certified glass-filled nylon

Sterilization: Gamma Radiation up to 50 kGy, autoclavable up to 273°F (134°C) for a maximum of 30 min.

Sizes: .5" to .75" and 1" to 1.5"

Operating Temperature: -94°F (-70°C) to 140°F (60°C)

Maximum Pressure: 80 psi (conforms to ASME BPE-2014 PM-4.2.2)

Tube Clamps

Features & Benefits:

- Designed for use with silicone and TPE tubing
- Easy to use, one-handed closure - no tools needed
- Tamper evident and zip tie compatible
- SIP/CIP compatible

Specifications:

Materials: USP Class VI & ISO 11137 certified glass-filled nylon

Sterilization: Gamma Radiation up to 50 kGy, autoclavable up to 273°F (134°C) for a maximum of 30 min.

Sizes: .5" to 1.25" Tubing OD

Operating Temperature: -94°F (-70°C) to 140°F (60°C)

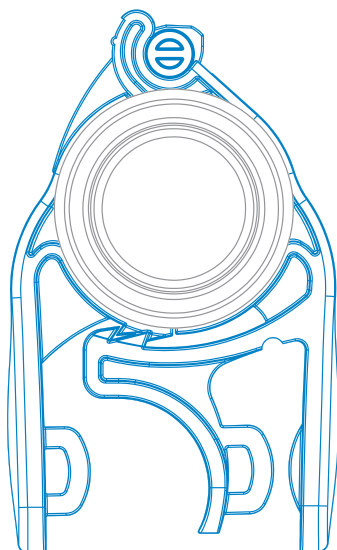

Easy, 2 Click Closure

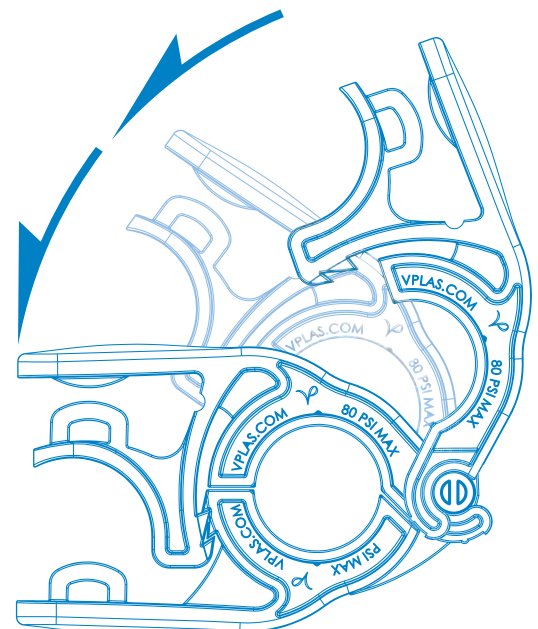

360° Compression

PHARMALOK SERIES:
Easy-Open Clamps

CPAX150 (-U71)

Tri-Clover Easy-Open Clamp for "Maxi" Flange, 1" to 1.5"



CPAN75 (-U71)

Tri-Clover Easy-Open Clamp for "Mini" Flange, .5" to .75"



BIOPROCESSING
FITTINGS

CPAX150 (-U75)

Tri-Clover Easy-Open Clamp for "Maxi" Flange, 1" to 1.5"



CPAN75 (-U75)

Tri-Clover Easy-Open Clamp for "Mini" Flange, .5" to .75"



CPAX150 (-U706)

Tri-Clover Easy-Open Clamp for "Maxi" Flange, 1" to 1.5"



CPAN75 (-U706)

Tri-Clover Easy-Open Clamp for "Mini" Flange, .5" to .75"



CPX150 (-U71)

Single-Use Series Clamp, TC Version 1" to 1.5"

CPN75 (-U71)

Single-Use Series Clamp, TC Version .5" to .75"



CPX150 (-U75)

Single-Use Series Clamp, TC Version 1" to 1.5"

CPN75 (-U75)

Single-Use Series Clamp, TC Version .5" to .75"



BIOPROCESSING
FITTINGS

PHARMALOK SERIES:
Tube Clamp

CPT100 (-U71)

Tube Clamp, .5" to 1.25"

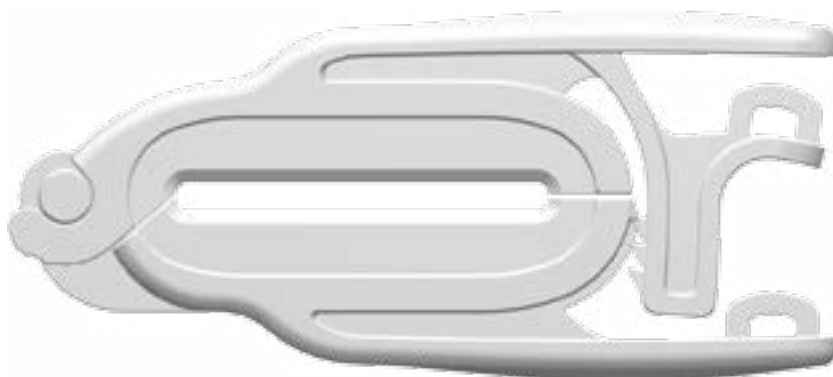

RQSeries

Quick Connects

Nordson MEDICAL has developed a more robust alternative for bioprocessing needs with the RQC Series and RQX Series offering a cost effective solution for flexible tubing connections in single use systems. The connector set is best in fit, form and function, and features a user-friendly interface that includes a large guarded button for a secure lock to guard against disconnects, and lofted lead-in for improved ease of connection. The more reliable locking feature gives you peace of mind knowing your connection is secure.

Features & Benefits:

- Materials meet USP Class VI and ISO 10993 criteria
- Several connector configurations available in commonly used polypropylene and polycarbonate materials
- Large ergonomic button and thumb pad with secure latch and optional integrated locking mechanism
- Platinum-cured silicone o-rings
- Plugs and caps available to maintain fluid path integrity
- Supports cryogenic applications to -60°C

Specifications:

- **Materials:** Polypropylene, Tinted Polycarbonate
- **Sterilization:** Gamma radiation stable, EtO compatible, autoclavable to 121°C for up to 20 minutes
- **Testing:** Bioburden, Cytotoxicity, Extractables
- **RQC Series Tubing Sizes:** 1/4" (6.4 mm) and 3/8" (9.5 mm) tubing IDs
- **RQX Series Tubing Sizes:** 3/8" (9.5 mm) and 1/2" (12.7 mm) tubing IDs

RQC SERIES:

Quick Connects

RQCF655 (-9024 -001) RQCF655 (-6005 -001)

Female Open Flow, 600 Series Barb, 1/4" (6.4 mm) ID Tubing



RQCFL655 (-9024 -001) RQCFL655 (-6005 -001)

Female Open Flow, 600 Series Barb, 1/4" (6.4 mm) ID Tubing, Locking Feature



RQCM655 (-9024 -001) Platinum-Cured Silicone O-Ring RQCM655 (-6005 -001) Platinum-Cured Silicone O-Ring

Male Open Flow, 600 Series Barb, 1/4" (6.4 mm) ID Tubing



RQCF670 (-9024 -001) RQCF670 (-6005 -001)

Female Open Flow, 600 Series Barb, 3/8" (9.5 mm) ID Tubing



RQCFL670 (-9024 -001) RQCFL670 (-6005 -001)

Female Open Flow, 600 Series Barb, 3/8" (9.5 mm) ID Tubing, Locking Feature



RQCM670 (-9024 -001) Platinum-Cured Silicone O-Ring RQCM670 (-6005 -001) Platinum-Cured Silicone O-Ring

Male Open Flow, 600 Series Barb, 3/8" (9.5 mm) ID Tubing



RQCFC (-9024 -001) RQCFC (-6005 -001)

Female Cap



RQCFLC (-9024 -001) RQCFLC (-6005 -001)

Female Cap, Locking Feature



RQCMP (-9024 -001) Platinum-Cured Silicone O-Ring RQCMP (-6005 -001) Platinum-Cured Silicone O-Ring

Male Plug



RQXF670 (-9024 -001)
RQXF670 (-6005 -001)

Female Open Flow, 600 Series Barb, 3/8" (9.5 mm) ID Tubing



RQXF680 (-9024 -001)
RQXF680 (-6005 -001)

Female Open Flow, 600 Series Barb, 1/2" (12.7 mm) ID Tubing



RQXFL670 (-9024 -001)
RQXFL670 (-6005 -001)

Female Open Flow, 600 Series Barb, 3/8" (9.5 mm) ID Tubing, Locking Feature



RQXFL680 (-9024 -001)
RQXFL680 (-6005 -001)

Female Open Flow, 600 Series Barb, 1/2" (12.7 mm) ID Tubing, Locking Feature



RQXM670 (-9024 -001) Platinum-Cured Silicone O-Ring
RQXM670 (-6005 -001) Platinum-Cured Silicone O-Ring

Male Open Flow, 600 Series Barb, 3/8" (9.5 mm) ID Tubing



RQXM680 (-9024 -001) Platinum-Cured Silicone O-Ring
RQXM680 (-6005 -001) Platinum-Cured Silicone O-Ring

Male Open Flow, 600 Series Barb, 1/2" (12.7 mm) ID Tubing



BIOPROCESSING FITTINGS

RQXFC (-9024 -001)
RQXFC (-6005 -001)

Female Cap



RQXFLC (-9024 -001)
RQXFLC (-6005 -001)

Female Cap, Locking Feature



RQXMP (-9024 -001) Platinum-Cured Silicone O-Ring
RQXMP (-6005 -001) Platinum-Cured Silicone O-Ring

Male Plug



Need Samples for Evaluation?

You can call to request most of our standard product in quantities of 5, or less, for free application evaluation.

+1 (970) 267-5200 Toll Free: (888) 404-5837

SF Series

Sanitary Fittings

The SF Series sanitary fittings are based on design concepts calling for a heavy-duty part with superior side load strength, while providing superior flow-through characteristics, making them the connectors of choice for single-use bioprocesses. Pharmaceutical professionals find these plastic fittings offer all the benefits of disposable parts while offering performance capabilities not found in earlier versions of flanged fittings.

Features & Benefits:

- Animal-free materials: No BSE documentation required
- Radiused flow surfaces: Smooth uninterrupted flow
- "Mini" & "Maxi" sizes: Easy to retrofit current operations, works with commercially available biopharm clamps
- No Particulate build-up: Interior surface controlled to 15 Ra microinch

Specifications:

Materials: Animal-Free Polypropylene, Natural PVDF

Tubing Sizes: 1/4", 3/8", 1/2", 3/4", 1"

Leak Resistance: Tested at 80 psi air under water for 90 seconds with no leaks

Tubing Removal Force:

- 1/4" PP with C-Flex® shore A tubing: 21 lbs.
- 1/2" PP with C-Flex® shore A tubing: 89 lbs.
- 1" PP with C-Flex® shore A tubing: 121 lbs.

Interior Surface Finish: 15 Ra Microinch

SFMN655 (-6005 -J1A)

Sanitary Fitting, Mini Flange 3/4" to 600 Series Barb, 1/4" (6.4 mm) Tubing ID



SFMN670 (-6005 -J1A)

Sanitary Fitting, Mini Flange 3/4" to 600 Series Barb, 3/8" (9.5 mm) Tubing ID



SFMN680 (-6005 -J1A)

Sanitary Fitting, Mini Flange 3/4" to 600 Series Barb, 1/2" (12.7 mm) Tubing ID



SFMN6100 (-6005 -J1A)

Sanitary Fitting, Mini Flange 3/4" to 600 Series Barb, 3/4" (19.0 mm) Tubing ID



SFMNC (-6005 -J1A)

Sanitary Fitting Mini Cap 3/4"



Technical Assistance

Trying to choose the correct part? Need more material information than is published in this catalog? Call Nordson MEDICAL Technical Support (970) 267-5200.

SFMX655 (-6005 -J1A)

Sanitary Fitting, Maxi Flange 1-1/2" to 600 Series Barb, 1/4" (6.4 mm) Tubing ID



SFMX6100 (-6005 -J1A)

Sanitary Fitting, Maxi Flange 1-1/2" to 600 Series Barb, 3/4" (19.0 mm) Tubing ID



SFMX670 (-6005 -J1A)

Sanitary Fitting, Maxi Flange 1-1/2" to 600 Series Barb, 3/8" (9.5 mm) Tubing ID



SFMX6110 (-6005 -J1A)

Sanitary Fitting, Maxi Flange 1-1/2" to 600 Series Barb, 1.0" (25.4 mm) Tubing ID

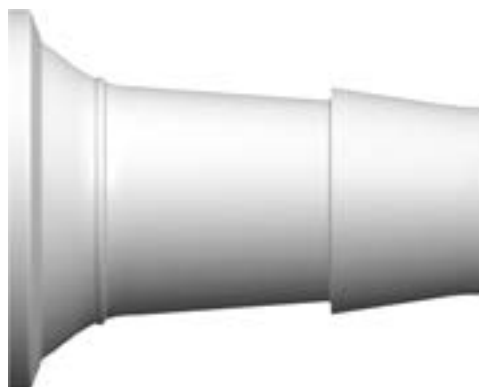

SFMX680 (-6005 -J1A)

Sanitary Fitting, Maxi Flange 1-1/2" to 600 Series Barb, 1/2" (12.7 mm) Tubing ID



SFMXC (-6005 -J1A)

Sanitary Fitting Maxi Cap 1-1/2"



BIOPROCESSING
FITTINGS

TUBE-TO-TUBE

Connectors



Reference part shown: **N070/013**

Did You Know?

You can find smaller Tube-To-Tube fittings for your application needs starting on **Pg-72**.

LARGE TUBE-TO-TUBE: Straight Through



Reference part shown: **N670**

Due to size we are not able to display all large Tube-To-Tube connectors. Please see www.nordsonmedical.com for part reference. Minimum package quantities vary by tube IDs, please verify minimum package sizes when placing orders.

N070 (-0 -6005 -9)

Straight Through Connector with 500 Series Barbs, 3/8" (9.5 mm) ID Tubing

N670 (-6005 -9 -J1A)

Straight Through Connector with 600 Series Barbs, 3/8" (9.5 mm) ID Tubing

N970 (-9)

Straight Through Connector with 900 Series Barbs, 3/8" (9.5 mm) ID Tubing

N080 (-0 -6005 -9)

Straight Through Connector with 500 Series Barbs, 1/2" (12.7 mm) ID Tubing

N680 (-6005 -9 -J1A)

Straight Through Connector with 600 Series Barbs, 1/2" (12.7 mm) ID Tubing

N975 (-9)

Straight Through Connector with 900 Series Barbs, 1/2" (12.7 mm) ID Tubing

N090 (-0 -6005 -9)

Straight Through Connector with 500 Series Barbs, 5/8" (16.0 mm) ID Tubing

N690 (-0 -6005 -9)

Straight Through Connector with 600 Series Barbs, 5/8" (16.0 mm) ID Tubing

N100 (-0 -6005)

Straight Through Connector with 500 Series Barbs, 3/4" (19.0 mm) ID Tubing

N6100 (-6005)

Straight Through Connector with 600 Series Barbs, 3/4" (19.0 mm) ID Tubing

N110 (-0 -6005)

Straight Through Connector with 500 Series Barbs, 1" (25.4 mm) ID Tubing

N6110 (-6005)

Straight Through Connector with 600 Series Barbs, 1" (25.4 mm) ID Tubing

Due to size we are not able to display all large Tube-To-Tube connectors. Please see www.nordsonmedical.com for part reference. Minimum package quantities vary by tube IDs, please verify minimum package sizes when placing orders.

N070/013 (-0 -6005 -9 -9002 -J1A)

Straight Through Reduction Connector with 500 Series Barbs, 3/8" (9.5 mm) and 1/8" (3.2 mm) ID Tubing

N070/055 (-0 -6005 -9)

Straight Through Reduction Connector with 500 Series Barbs, 3/8" (9.5 mm) and 1/4" (6.4 mm) ID Tubing

N670/655 (-6005 -9 -J1A)

Straight Through Reduction Connector with 600 Series Barbs, 3/8" (9.5 mm) and 1/4" (6.4 mm) ID Tubing

N080/055 (-0 -6005 -9)

Straight Through Reduction Connector with 500 Series Barbs, 1/2" (12.7 mm) and 1/4" (6.4 mm) ID Tubing

N680/655 (-6005 -9 -J1A)

Straight Through Reduction Connector with 600 Series Barbs, 1/2" (12.7 mm) and 1/4" (6.4 mm) ID Tubing

N080/070 (-0 -6005 -9)

Straight Through Reduction Connector with 500 Series Barbs, 1/2" (12.7 mm) and 3/8" (9.5 mm) ID Tubing

N680/670 (-6005 -9)

Straight Through Reduction Connector with 600 Series Barbs, 1/2" (12.7 mm) and 3/8" (9.5 mm) ID Tubing

N090/055 (-0 -6005)

Straight Through Reduction Connector with 500 Series Barbs, 5/8" (16.0 mm) and 1/4" (6.4 mm) ID Tubing

N690/655 (-6005 -9)

Straight Through Reduction Connector with 600 Series Barbs, 5/8" (16.0 mm) and 1/4" (6.4 mm) ID Tubing

N090/070 (-0 -6005)

Straight Through Reduction Connector with 500 Series Barbs, 5/8" (16.0 mm) and 3/8" (9.5 mm) ID Tubing

N690/670 (-6005 -9)

Straight Through Reduction Connector with 600 Series Barbs, 5/8" (16.0 mm) and 3/8" (9.5 mm) ID Tubing

N6100/670 (-6005)

Straight Through Reduction Connector with 600 Series Barbs, 3/4" (19 mm) and 3/8" (9.5 mm) ID Tubing

N100/080 (-0 -6005)

Straight Through Reduction Connector with 500 Series Barbs, 3/4" (19.0 mm) and 1/2" (12.7 mm) ID Tubing

N6100/680 (-6005)

Straight Through Reduction Connector with 600 Series Barbs, 3/4" (19 mm) and 1/2" (12.7 mm) ID Tubing

N6110/680 (-6005)

Straight Through Reduction Connector with 600 Series Barbs, 1" (25.4 mm) and 1/2" (12.7 mm) ID Tubing

N110/100 (-0 -6005)

Straight Through Reduction Connector with 500 Series Barbs, 1" (25.4 mm) and 3/4" (19.0 mm) ID Tubing

N6110/6100 (-6005 -9)

Straight Through Reduction Connector with 600 Series Barbs, 1" (25.4 mm) and 3/4" (19.0 mm) ID Tubing



Reference part shown: L070

Due to size we are not able to display all large Tube-To-Tube connectors. Please see www.nordsonmedical.com for part reference. Minimum package quantities vary by tube IDs, please verify minimum package sizes when placing orders.

L070 (-0 -6005)

Elbow Connector with 500 Series Barbs, 3/8" (9.5 mm) ID Tubing

L970 (-9)

Elbow Connector with 900 Series Barbs, 3/8" (9.5 mm) ID Tubing

L080 (-0 -6005)

Elbow Connector with 500 Series Barbs, 1/2" (12.7 mm) ID Tubing

L975 (-9)

Elbow Connector with 900 Series Barbs, 1/2" (12.7 mm) ID Tubing

L090 (-0 -6005)

Elbow Connector with 500 Series Barbs, 5/8" (16.0 mm) ID Tubing

L100 (-0 -6005)

Elbow Connector with 500 Series Barbs, 3/4" (19.0 mm) ID Tubing

L110 (-0 -6005)

Elbow Connector with 500 Series Barbs, 1" (25.4 mm) ID Tubing

L6110 (-6005)

Elbow Connector with 600 Series Barbs, 1" (25.4 mm) ID Tubing

CF494 (-6 -6005)

Low-profile Elbow Connector with Custom 600 Series Barbs, 1" (25.4 mm) ID Tubing



Reference part shown: L070/055

Due to size we are not able to display all large Tube-To-Tube connectors. Please see www.nordsonmedical.com for part reference. Minimum package quantities vary by tube IDs, please verify minimum package sizes when placing orders.

L070/055 (-0 -6005)

Elbow Reduction Connector with 500 Series Barbs, 3/8" (9.5 mm) and 1/4" (6.4 mm) ID Tubing

L080/070 (-0 -6005)

Elbow Reduction Connector with 500 Series Barbs, 1/2" (12.7 mm) and 3/8" (9.5 mm) ID Tubing

L100/080 (-0 -6005)

Elbow Reduction Connector with 500 Series Barbs, 3/4" (19.0 mm) and 1/2" (12.7 mm) ID Tubing

L110/100 (-0 -6005)

Elbow Reduction Connector with 500 Series Barbs, 1" (25.4 mm) and 3/4" (19.0 mm) ID Tubing

Need More Details?

Check out all of our bioprocessing components at www.bioprocesscomponents.com or contact Sales at sales@nordsonmedical.com.

Custom Assembly

We produce standard components to fit your current assemblies and devices, but we also provide custom solutions by applying a variety of assembly options, such as joining fittings, connectors, filters, and other components to tubing. From systems using a single fitting to complex configurations utilizing various components, we can design complete assemblies to your requirements.

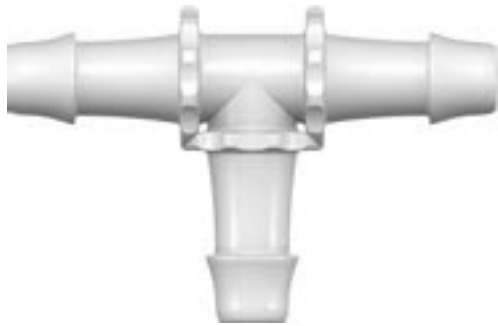

Reference part shown: T070

Due to size we are not able to display all large Tube-To-Tube connectors. Please see www.nordsonmedical.com for part reference. Minimum package quantities vary by tube IDs, please verify minimum package sizes when placing orders.

T070 (-0 -6005 -9)
Tee Connector with 500 Series Barbs, 3/8" (9.5 mm) ID Tubing

T670 (-1 -6005 -9 -J1A)
Tee Connector with 600 Series Barbs, 3/8" (9.5 mm) ID Tubing

T970 (-9)
Tee Connector with 900 Series Barbs, 3/8" (9.5 mm) ID Tubing

T080 (-0 -6005 -9)
Tee Connector with 500 Series Barbs, 1/2" (12.7 mm) ID Tubing

T680 (-6005 -9 -J1A)
Tee Connector with 600 Series Barbs, 1/2" (12.7 mm) ID Tubing

T975 (-9)
Tee Connector with 900 Series Barbs, 1/2" (12.7 mm) ID Tubing

T690 (-6005 -9)
Tee Connector with 600 Series Barbs, 5/8" (16.0 mm) ID Tubing

T100 (-0 -6005 -9)
Tee Connector with 500 Series Barbs, 3/4" (19.0 mm) ID Tubing

T6100 (-6005)
Tee Connector with 600 Series Barbs, 3/4" (19.0 mm) ID Tubing

T110 (-0 -6005)
Tee Connector with 500 Series Barbs, 1" (25.4 mm) ID Tubing

T6110 (-6005)
Tee Connector with 600 Series Barbs, 1" (25.4 mm) ID Tubing

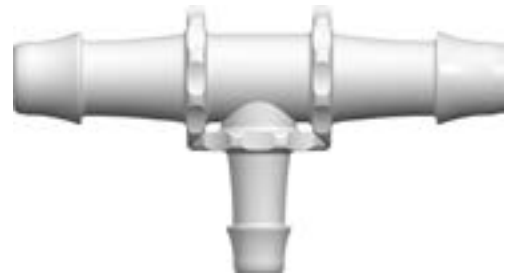

Reference part shown: T070/055

Due to size we are not able to display all large Tube-To-Tube connectors. Please see www.nordsonmedical.com for part reference. Minimum package quantities vary by tube IDs, please verify minimum package sizes when placing orders.

T070/055 (-0 -6005 -9)
Tee Reduction Connector with 500 Series Barbs, 3/8" (9.5 mm) and 1/4" (6.4 mm) ID Tubing

T080/055 (-0 -6005 -9)
Tee Reduction Connector with 500 Series Barbs, 1/2" (12.7 mm) and 1/4" (6.4 mm) ID Tubing

T080/070 (-0 -6005 -9)
Tee Reduction Connector with 500 Series Barbs, 1/2" (12.7 mm) and 3/8" (9.5 mm) ID Tubing

T100/080 (-0 -6005 -9)
Tee Reduction Connector with 500 Series Barbs, 3/4" (19.0 mm) and 1/2" (12.7 mm) ID Tubing

T110/100 (-0 -6005)
Tee Reduction Connector with 500 Series Barbs, 1" (25.4 mm) and 3/4" (19.0 mm) ID Tubing

BIOPROCESSING
FITTINGS



Reference part shown: **Y070**

Due to size we are not able to display all large Tube-To-Tube connectors. Please see www.nordsonmedical.com for part reference. Minimum package quantities vary by tube IDs, please verify minimum package sizes when placing orders.

Y070 (-0 -6005 -9)

Y Connector with 500 Series Barbs, 3/8" (9.5 mm) ID Tubing

Y670 (-6005 -9 -J1A)

Y Connector with 600 Series Barbs, 3/8" (9.5 mm) ID Tubing

Y080 (-0 -6005 -9)

Y Connector with 500 Series Barbs, 1/2" (12.7 mm) ID Tubing

Y680 (-6005 -9 -J1A)

Y Connector with 600 Series Barbs, 1/2" (12.7 mm) ID Tubing

Y090 (-0 -6005 -J1A)

Y Connector with 500 Series Barbs, 5/8" (16.0 mm) ID Tubing

Y690 (-6005)

Y Connector with 600 Series Barbs, 5/8" (16.0 mm) ID Tubing

Y100 (-0 -6005 -J1A)

Y Connector with 500 Series Barbs, 3/4" (19.0 mm) ID Tubing

Y6100 (-6005)

Y Connector with 600 Series Barbs, 3/4" (19.0 mm) ID Tubing

Y110 (-0 -6005)

Y Connector with 500 Series Barbs, 1" (25.4 mm) ID Tubing

Y6110 (-6005)

Y Connector with 600 Series Barbs, 1" (25.4 mm) ID Tubing



Reference part shown: **4PX655**

Due to size we are not able to display all large Tube-To-Tube connectors. Please see www.nordsonmedical.com for part reference. Minimum package quantities vary by tube IDs, please verify minimum package sizes when placing orders.

4PX655 (-6005)

Four-Port Cross Style Manifold with 600 Series Barbs for 1/4" (6.4 mm) ID Tubing

4PX670 (-6005)

Four-Port Cross Style Manifold with 600 Series Barbs for 3/8" (9.5 mm) ID Tubing

4PX680 (-6005)

Four-Port Cross Style Manifold with 600 Series Barbs for 1/2" (12.7 mm) ID Tubing

LARGE TUBE-TO-TUBE:

Press-In Plugs



Reference part shown: **PIP090**

Due to size we are not able to display all large Tube-To-Tube connectors. Please see www.nordsonmedical.com for part reference. Minimum package quantities vary by tube IDs, please verify minimum package sizes when placing orders.

PIP070 (-0 -6005)

Press-In Plug with 500 Series Barb, 3/8" (9.5 mm) ID Tubing

PIP670 (-6005)

Press-In Plug with 600 Series Barb, 3/8" (9.5 mm) ID Tubing

PIP080 (-6005)

Press-In Plug with 500 Series Barb, 1/2" (12.7 mm) ID tubing

PIP680 (-6005)

Press-In Plug with 600 Series Barb, 1/2" (12.7 mm) ID Tubing

PIP090 (-6005)

Press-In Plug with 500 Series Barb, 5/8" (16.0 mm) ID Tubing

PIP6100 (-6005)

Press-In Plug with 600 Series Barb, 3/4" (19.0 mm) ID Tubing

PIP6110 (-6005)

Press-In Plug with 600 Series Barb, 1" (25.4 mm) ID Tubing

TUOHY BORST

Adapters



Adult Without Side Port

PG-57



Pediatric Without Side Port

PG-57



Adult With Side Port

PG-57



TBASeries

Tuohy Borst Adapters

Tuohy Borst adapters are designed to facilitate catheter introduction and are intended for interventional and diagnostic procedures where fluid backflow is a concern.

Tuohy Borst adapters are available in convenient bag sizes of 100 and 25 with larger sizes attainable on request and lower minimum order quantities to suit your needs.

Features & Benefits:

- Male luer terminations that comply with EN/ISO standards
- With and without side ports for delivering medication
- Cap does not remove at fully opened position
- Leak proof seal during interventional and diagnostic procedures
- Materials: clear PVC, silicone adult gaskets, and Kraton pediatric gaskets
- Gasket through hole ID from 0.025" to 0.100"
- Different cap color options

Part Drawings Online!

Nordson MEDICAL provides dimensional drawings available for download for all of its fittings.
www.nordsonmedical.com

Need it Fast?

You can order any of our 4,000+ parts online now with no order \$ minimums, 24 hours a day, 7 days a week!
www.nordsonmedical.com

TBA SERIES:
Adult Without Side Port

TBA2025-001

Tuohy Borst Adapter without Side Port, 9 Fr Clear PVC Body, Blue Triax Cap, 0.025" ID Silicone Gasket



TBA2025-002

Tuohy Borst Adapter without Side Port, 9 Fr Clear PVC Body, Clear PVC Cap, 0.025" ID Silicone Gasket

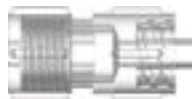

TBA2040-001

Tuohy Borst Adapter without Side Port, Clear PVC Body, Blue Triax Cap 0.040" ID Silicone Gasket



TBA2052-001

Tuohy Borst Adapter without Side Port, Clear PVC Body, Blue Triax Cap, 0.052" ID Silicone Gasket



TBA2062-001

Tuohy Borst Adapter without Side Port, Clear PVC Body, Blue Triax Cap, 0.062" ID Silicone Gasket



TBA2081-001

Tuohy Borst Adapter without Side Port, Clear PVC Body, Blue Triax Cap, 0.081" ID Silicone Gasket



TBA2100-001

Tuohy Borst Adapter without Side Port, Clear PVC Body, Clear PVC Cap, 0.100" ID Silicone Gasket



TBA SERIES:
Pediatric Without Side Port

TBA3084-001

Pediatric Tuohy Borst Adapter without Side Port, Clear PVC Body, Red Cap, 0.084" ID Natural Kraton Gasket



TBA SERIES:
Adult With Side Port

TBA4030P-001

Tuohy Borst Adapter with Side Port, Clear PVC Body, Blue Triax Cap, Pellethane Tubing, 0.030" ID Silicone Gasket, Acetal Mini-Clamp, Clear PVC Female Luer, and SS Washer



TBA4030P-002

Tuohy Borst Adapter with Side Port, Clear PVC Body, Blue Triax Cap, 0.030" ID Silicone Gasket, Pellethane Tubing, Clear PVC Female Luer, Acetal Mini Clamp, HDPE and Teflon Washers



Looking for Something Different?

Most of our best product ideas have come from you, our customers. While we pride ourselves on our extensive product offering, we recognize that your needs are ever-changing and that our products, too, must adapt to your needs.

If there's a new product you think Nordson MEDICAL should make, please send us an Email at designcenter@nordsonmedical.com describing your product concept in as much detail as you desire. We will contact you with any questions, and who knows - the next catalog edition could include products YOU told us to build.

See page 14 for more information on the Design Center!



LUER

Fittings



Male Luers
PG-59



Female Luers
PG-61



Adapters
PG-63



Couplers
PG-63



Tees
PG-63



Elbows
PG-63



Plugs and Caps
PG-64



Luer to Thread
PG-65



Panel Mounts & Accessories
PG-66



Our Luer Tapers

Nordson MEDICAL's luer tapers are made to the ISO 594-1 and ISO 594-2 standards, and may be connected to other luers meeting these ISO standards. Please test your application to verify the performance of the interconnection.

Nordson MEDICAL's luer fittings come in over 100 configurations and several materials for the device designer, joining tubing from 1/16" (1.6 mm) ID to 1/4" (6.4 mm) ID.

Features & Benefits:

Published ISO Design Standard

- Well understood worldwide
- Often assures interconnections without need to retrofit

Rotating Lock Permits Tube Positioning Prior To Tightening

- Minimizes twisting and kinking of tubing

Tapered Cone Seal

- Reliable
- Inexpensive
- Uncomplicated

Available In Many Materials

- Facilitates optimal material selection for your application

Inexpensive

- Facilitates single-use

Easy To Understand

- Ease of use in field

Many Configuration Options

- Adaptable to wide range of applications

Security Options (Fixed Lock, Rotating Lock, No Lock)

- Tailorable to your specific application

Custom Assembly

We produce standard components to fit your current assemblies and devices, but we also provide custom solutions by applying a variety of assembly options, such as joining fittings, connectors, filters, and other components to tubing. From systems using a single fitting to complex configurations utilizing various components, we can design complete assemblies to your requirements.

MALE LUER: Integral Lock Ring

MTLL210 (-1 -2 -3 -4 -5 -06 -6005 -6012 -07 -9 -9002 -J1A)
Male Luer Integral Lock Ring to 200 Series Barb, 1/16" (1.6 mm) ID Tubing



MTLL410 (-1 -6005 -9 -9002 -J1A)
Male Luer Integral Lock Ring to 400 Series Barb, 1/16" (1.6 mm) ID Tubing



MTLL004 (-1 -2 -3 -4 -5 -06 -6005 -07 -9 -9002)
Male Luer Integral Lock Ring to 500 Series Barb, 1/16" (1.6 mm) ID Tubing



MTLL220 (-1 -2 -3 -4 -5 -06 -6005 -6012 -07 -9 -9002 -J1A)
Male Luer Integral Lock Ring to 200 Series Barb, 3/32" (2.4 mm) ID Tubing



MTLL420 (-1 -6005 -9 -9002 -J1A)
Male Luer Integral Lock Ring to 400 Series Barb, 3/32" (2.4 mm) ID Tubing



MTLL007 (-1 -2 -3 -4 -5 -6005 -06 -07 -9 -9002)
Male Luer Integral Lock Ring to 500 Series Barb, 3/32" (2.4 mm) ID Tubing



MTLL230 (-1 -2 -3 -4 -5 -06 -6005 -6012 -07 -9 -9002 -J1A -CM550)
Male Luer Integral Lock Ring to 200 Series Barb, 1/8" (3.2 mm) ID Tubing



MTLL430 (-1 -3 -6005 -9 -9002 -J1A)
Male Luer Integral Lock Ring to 400 Series Barb, 1/8" (3.2 mm) ID Tubing



MTLL013 (-1 -2 -3 -4 -5 -06 -6005 -07 -9 -9002)
Male Luer Integral Lock Ring to 500 Series Barb, 1/8" (3.2 mm) ID Tubing



MTLL240 (-1 -2 -3 -4 -5 -6005 -6012 -06 -07 -9 -9002 -J1A)
Male Luer Integral Lock Ring to 200 Series Barb, 5/32" (4.0 mm) ID Tubing



MTLL025 (-1 -2 -3 -4 -5 -6005 -06 -07 -9 -9002)
Male Luer Integral Lock Ring to 500 Series Barb, 5/32" (4.0 mm) ID Tubing



MTLL445 (-1 -6005 -9 -9002 -J1A)
Male Luer Integral Lock Ring to 400 Series Barb, .170" (4.3 mm) ID Tubing



MTLL250 (-1 -2 -3 -4 -5 -06 -6005 -07 -8003 -9 -9002 -J1A)
Male Luer Integral Lock Ring to 200 Series Barb, 3/16" (4.8 mm) ID Tubing



MTLL450 (-1 -6005 -9 -9002 -J1A)
Male Luer Integral Lock Ring to 400 Series Barb, 3/16" (4.8 mm) ID Tubing



MTLL035 (-1 -2 -3 -4 -5 -06 -6005 -07 -9 -9002)
Male Luer Integral Lock Ring to 500 Series Barb, 3/16" (4.8 mm) ID Tubing



MTLL360 (-1 -2 -6005 -6012 -9 -9002 -J1A)
Male Luer Integral Lock Ring to 300 Series Barb, 1/4" (6.4 mm) ID Tubing



MTLL055 (-1 -2 -3 -4 -06 -6005 -07 -9 -9002)
Male Luer Integral Lock Ring to 500 Series Barb, 1/4" (6.4 mm) ID Tubing



LUER
FITTINGS

Part Drawings Online!

Nordson MEDICAL provides dimensional drawings available for download for all of its fittings.
www.nordsonmedical.com

MALE LUER:

Slip, or for use with Lock Ring

FSLLR (-1 -2 -3 -4 -5 -06 -6005 -6012 -07 -9 -9002)

Finger Snap Luer Lock Ring



MLRL004 (-1 -6005 -9)

Male Luer to 500 Series Barb, 1/16" (1.6 mm) ID Tubing (May be used with separate rotating lock ring; FSLLR)



MLSL004 (-1 -6005 -9)

Male Luer to 500 Series Barb, 1/16" (1.6 mm) ID Tubing (May be used with separate stationary lock ring; FSLLR)



MLRL007 (-1 -6005 -6012 -9)

Male Luer to 500 Series Barb, 3/32" (2.4 mm) ID Tubing (May be used with separate rotating lock ring; FSLLR)



MLSL007 (-1 -6005 -9)

Male Luer to 500 Series Barb, 3/32" (2.4 mm) ID Tubing (May be used with separate stationary lock ring; FSLLR)



MLRL013 (-1 -6005 -6012 -9)

Male Luer to 500 Series Barb, 1/8" (3.2 mm) ID Tubing (May be used with separate rotating lock ring; FSLLR)



MLSL013 (-1 -6005 -9)

Male Luer to 500 Series Barb, 1/8" (3.2 mm) ID Tubing (May be used with separate stationary lock ring; FSLLR)



MLRL025 (-1 -6005 -6012 -9)

Male Luer to 500 Series Barb, 5/32" (4.0 mm) ID Tubing (May be used with separate rotating lock ring; FSLLR)



MLSL025 (-1 -6005 -9)

Male Luer to 500 Series Barb, 5/32" (4.0 mm) ID Tubing (May be used with separate stationary lock ring; FSLLR)



MLRL035 (-1 -6005 -6012 -9 -9002)

Male Luer to 500 Series Barb, 3/16" (4.8 mm) ID Tubing (May be used with separate rotating lock ring; FSLLR)



MLSL035 (-1 -6005 -9)

Male Luer to 500 Series Barb, 3/16" (4.8 mm) ID Tubing (May be used with separate stationary lock ring; FSLLR)



MLRL055 (-1 -6005 -9)

Male Luer to 500 Series Barb, 1/4" (6.4 mm) ID Tubing (May be used with separate rotating lock ring; FSLLR)



MLSL055 (-1 -6005 -9)

Male Luer to 500 Series Barb, 1/4" (6.4 mm) ID Tubing (May be used with separate stationary lock ring; FSLLR)



LUER FITTINGS

It's a Lock with Nordson MEDICAL!

Our MLRL and MLSL Series of fittings can be used both as a slip luer or as a locking luer with the addition of our FSLLR luer lock ring, which allows color coding without flow path contact. Our MLSL/FSLLR combination results in a stationary lock ring. Use a combination of MLRL and FSLLR to create a color coded rotating lock ring.



Used together, you can create a color coded male luer with lock ring

MALE LUER:

Slip

MTLS210 (-1 -6005 -9 -J1A)

Male Luer Slip to 200 Series Barb, 1/16" (1.6 mm) ID Tubing



MSL004 (-1 -6005 -9 -9002)

Male Luer Slip to 500 Series Barb, 1/16" (1.6 mm) ID Tubing



MTLS220 (-1 -3 -5 -6005 -6012 -81 -9 -J1A)

Male Luer Slip to 200 Series Barb, 3/32" (2.4 mm) ID Tubing



MSL007 (-1 -6005 -9 -9002)

Male Luer Slip to 500 Series Barb, 3/32" (2.4 mm) ID Tubing



MTLS230 (-1 -3 -5 -6005 -81 -9 -9002 -J1A)

Male Luer Slip to 200 Series Barb, 1/8" (3.2 mm) ID Tubing



MSL013 (-1 -6005 -9 -9002)

Male Luer Slip to 500 Series Barb, 1/8" (3.2 mm) ID Tubing



MTLS240 (-1 -2 -5 -6005 -81 -9 -J1A)

Male Luer Slip to 200 Series Barb, 5/32" (4.0 mm) ID Tubing



MSL025 (-1 -6005 -9 -9002)

Male Luer Slip to 500 Series Barb, 5/32" (4.0 mm) ID Tubing



MSL035 (-1 -6005 -9 -9002 -J1A)

Male Luer Slip to 500 Series Barb, 3/16" (4.8 mm) ID Tubing



MSL055 (-1 -6005 -9 -9002)

Male Luer Slip to 500 Series Barb, 1/4" (6.4 mm) ID Tubing



FEMALE LUER:

Thread Style

FTLL210 (-1 -2 -3 -4 -5 -6005 -6012 -9 -9002 -J1A)

Female Luer Thread Style to 200 Series Barb, 1/16" (1.6 mm) ID Tubing



FTLL410 (-1 -6005 -9 -9002 -J1A)

Female Luer Thread Style to 400 Series Barb, 1/16" (1.6 mm) ID Tubing



FTLL004 (-1 -2 -3 -4 -5 -06 -6005 -07 -9 -9002 -J1A)

Female Luer Thread Style to 500 Series Barb, 1/16" (1.6 mm) ID Tubing



FTLL220 (-1 -2 -3 -5 -6005 -6012 -9 -9002 -J1A)

Female Luer Thread Style to 200 Series Barb, 3/32" (2.4 mm) ID Tubing



FTLL420 (-1 -6005 -9 -9002 -J1A)

Female Luer Thread Style to 400 Series Barb, 3/32" (2.4 mm) ID Tubing



FTLL007 (-1 -2 -3 -4 -5 -06 -6005 -07 -9 -9002)

Female Luer Thread Style to 500 Series Barb, 3/32" (2.4 mm) ID Tubing



FTLL230 (-1 -2 -3 -5 -6005 -6012 -9 -9002 -J1A -CM550)

Female Luer Thread Style to 200 Series Barb, 1/8" (3.2 mm) ID Tubing



FTLL430 (-1 -6005 -9 -9002 -J1A)

Female Luer Thread Style to 400 Series Barb, 1/8" (3.2 mm) ID Tubing



FTLL013 (-1 -2 -3 -4 -5 -06 -6005 -07 -9 -9002)

Female Luer Thread Style to 500 Series Barb, 1/8" (3.2 mm) ID Tubing



LUER
FITTINGS

FEMALE LUER: Thread Style

FTLL240 (-1 -2 -3 -5 -6005 -6012 -9 -9002 -J1A)
Female Luer Thread Style to 200 Series Barb, 5/32" (4.0 mm) ID Tubing



FTLL025 (-1 -2 -3 -4 -5 -06 -6005 -07 -9 -9002)
Female Luer Thread Style to 500 Series Barb, 5/32" (4.0 mm) ID Tubing



FTLL445 (-1 -6005 -9 -9002 -J1A)
Female Luer Thread Style to 400 Series Barb, .170" (4.3 mm) ID Tubing



FTLL250 (-1 -3 -5 -6005 -9 -9002 -J1A)
Female Luer Thread Style to 200 Series Barb, 3/16" (4.8 mm) ID Tubing



FTLL450 (-1 -6005 -9 -9002 -J1A)
Female Luer Thread Style to 400 Series Barb, 3/16" (4.8 mm) ID Tubing



FTLL035 (-1 -2 -3 -4 -5 -06 -6005 -07 -9 -9002 -J1A)
Female Luer Thread Style to 500 Series Barb, 3/16" (4.8 mm) ID Tubing



FTLL360 (-1 -3 -5 -6005 -6012 -9 -9002 -J1A)
Female Luer Thread Style to 300 Series Barb, 1/4" (6.4 mm) ID Tubing



FTLL055 (-1 -2 -3 -4 -5 -06 -6005 -07 -9 -9002)
Female Luer Thread Style to 500 Series Barb, 1/4" (6.4 mm) ID Tubing



FEMALE LUER: Smooth Bore Thread Style

FTLLSB004 (-1 -6005 -9)
Female Luer Thread Style Smooth Bore to 500 Series Barb, 1/16" (1.6 mm) ID Tubing



FTLLSB007 (-1 -4 -6005 -9)
Female Luer Thread Style Smooth Bore to 500 Series Barb, 3/32" (2.4 mm) ID Tubing



FTLLSB013 (-1 -6005 -9)
Female Luer Thread Style Smooth Bore to 500 Series Barb, 1/8" (3.2 mm) ID Tubing



Why Choose a Smooth Bore?

Our Smooth Bore Luers have a smooth inner transition providing for easy insertion of guide wires, probes and other devices.

FEMALE LUER: Lug Style

FTL10 (-1 -6005 -9 -J1A)
Female Luer Lug Style to Classic Series Barb, 1/16" (1.6 mm) ID Tubing



FTL210 (-1 -6005 -9 -J1A)
Female Luer Lug Style to 200 Series Barb, 1/16" (1.6 mm) ID Tubing



FTL20 (-1 -6005 -07 -81 -9 -J1A)
Female Luer Lug Style to Classic Series Barb, 3/32" (2.4 mm) ID Tubing



FTL220 (-1 -3 -5 -6005 -6012 -9 -J1A)
Female Luer Lug Style to 200 Series Barb, 3/32" (2.4 mm) ID Tubing



FTL30 (-1 -6005 -6012 -9 -J1A)
Female Luer Lug Style to Classic Series Barb, 1/8" (3.2 mm) ID Tubing



FEMALE LUER:

Lug Style

FTL230 (-1 -3 -5 -6005 -9 -J1A)

Female Luer Lug Style to 200 Series Barb, 1/8" (3.2 mm) ID Tubing



FTL240 (-1 -6005 -9 -J1A)

Female Luer Lug Style to 200 Series Barb, 5/32" (4.0 mm) ID Tubing



LUER:

Adapters, Couplers, and Lock Rings

FSLLR (-1 -2 -3 -4 -5 -06 -6005 -6012 -07 -9 -9002)

Finger Snap Luer Lock Ring



MLRLC (-1 -6005 -9)

Male Luer Coupler (May be used with separate rotating lock rings; FSLLR)



MTLCS (-1 -6005 -9 -J1A)

Male Luer Slip Coupler



FTLLC (-1 -6005 -9 -9002 -J1A)

Female Luer Thread Style Coupler



FTLC (-1 -6005 -9 -9002 -J1A)

Female Luer Lug Style Coupler



LC34 (-1 -6005 -9 -9002 -J1A)

Male Luer Integral Lock Ring to Female Luer Thread Style Coupler

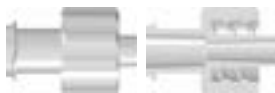

LC78 (-1 -6005 -9 -9002 -J1A)

Male Luer to Female Luer Thread Style Coupler (May be used with separate rotating lock ring; FSLLR)



LT878 (-1 -6005 -9 -9002)

Female Luer Thread Style (2) to Male Luer Tee (May be used with separate rotating lock ring; FSLLR)



LT787 (-1 -6005 -8012 -9 -9002)

Male Luer (2) to Female Luer Thread Style Tee (May be used with separate rotating lock ring; FSLLR)



FTLT (-1 -6005 -9 -J1A)

Female Luer Lug Style Tee



FTLLE (-1 -6005 -9 -J1A)

Female Luer Thread Style Elbow



FTLE (-1 -6005 -9 -J1A)

Female Luer Lug Style Elbow



LE87 (-1 -6005 -8003 -9 -9002)

Male Luer to Female Luer Thread Style Elbow (May be used with separate rotating lock ring; FSLLR)



LE7220 (-1 -2 -9 -6012)

Male Luer to 200 Series Barb Elbow, 3/32" (2.4 mm) ID Tubing (May be used with separate rotating lock ring; FSLLR)



LUER: Adapters, Couplers, and Lock Rings

LE7230 (-1 -2 -6005 -6012 -9 -9010)

Male Luer to 200 Series Barb Elbow 1/8" (3.2 mm) ID Tubing (May be used with separate rotating lock ring; FSLLR)



CA091 (-001) Gamma Stable Polycarbonate

Male Luer Elbow to 3/16" Classic Series Barb, (CF361-9002) with Rotating Lock Ring (FSLLR-9002)



LUER
FITTINGS

LUER: Plugs and Caps

MTLLP (-1 -2 -3 -6005 -6012 -07 -9 -J1A)

Male Luer Integral Lock Ring Plug, Closed at Luer Tip



LP4 (-1 -2 -3 -4 -5 -6005 -9 -9002 -J1A)

Male Luer Integral Lock Ring Plug, Closed at Grip



VLP4 (-1 -3 -6005 -81 -J1A)

Male Luer Integral Lock Ring Vented Plug, Closed at Grip



MLRLP (-1 -6005 -9)

Male Luer Plug (May be used with separate rotating lock ring; FSLLR)



MLSLP (-1 -6005 -9)

Male Luer Plug (May be used with separate stationary lock ring; FSLLR)



MTLP (-1 -6005 -9 -J1A)

Male Luer Plug, Closed at Tether Loop (May be used with separate stationary lock ring; MLLR)



MTLSP (-1 -6005 -81 -9 -J1A)

Male Luer Slip Plug, Closed at Grip



FTLP (-1 -6005 -9 -J1A)

Female Luer Lug Style Cap with Tether Loop



FTLLP (-1 -2 -3 -5 -6005 -6012 -07 -81 -9 -9002 -J1A)

Female Luer Thread Style Cap



LP34 (-1 -3 -5 -6005 -9 -9002 -J1A)

Male Luer Integral Lock Ring to Female Luer Thread Style Plug



Need Samples for Evaluation?

You can call to request most of our standard product in quantities of 5, or less, for free application evaluation.

+1 (970) 267-5200 Toll Free: (888) 404-5837

Need it Fast?

You can order any of our 4,000+ parts online now with no order \$ minimums, 24 hours a day, 7 days a week!

www.nordsonmedical.com

LUER TO THREAD:

Male

ABSML-6005 UNDER (-1 -2 -3 -4 -5 -06 -07 -6012)

Male Luer with Rotating Lock Ring and 5/16" Hex to 1/4-28 UNF Bottom Sealing Thread



ABSML-J1A UNDER (-1 -2 -3 -4 -5 -06 -07)

Male Luer with Rotating Lock Ring and 5/16" Hex to 1/4-28 UNF Bottom Sealing Thread



XMTLL (-1 -6005 -9 -J1A)

Male Luer Integral Lock Ring to 10-32 Special Tapered Thread



SMTLL (-1 -6005 -6012 -9 -J1A)

Male Luer Integral Lock Ring to 1/4-28 UNF Thread



18MTLL (-1 -2 -6005 -6012 -J1A)

Male Luer Integral Lock Ring with 7/16" Hex to 1/8-27 NPT Thread



14MTLL (-1 -2 -6005 -6012)

Male Luer Integral Lock Ring with 9/16" Hex to 1/4-18 NPT Thread



XMLRL (-1 -6005 -9 -9002)

Male Luer with 1/4" Hex to 10-32 Special Tapered Thread (May be used with separate rotating lock ring; FSLLR)



SMLRL (-1 -6005 -9 -J1A)

Male Luer with 5/16" Hex to 1/4-28 UNF Thread (May be used with separate rotating lock ring; FSLLR)



BSMLRL (-6005 -J1A)

Male Luer with 5/16" Hex to 1/4-28 Bottom-Sealing Thread (May be used with separate rotating lock ring; FSLLR)



LUER
FITTINGS

Looking for Something Different?

Most of our best product ideas have come from you, our customers. While we pride ourselves on our extensive product offering, we recognize that your needs are ever-changing and that our products, too, must adapt to your needs.

If there's a new product you think Nordson MEDICAL should make, please send us an Email at designcenter@nordsonmedical.com describing your product concept in as much detail as you desire. We will contact you with any questions, and who knows - the next catalog edition could include products YOU told us to build.

See page 14 for more information on the Design Center!



Need More Details?

Part drawings, minimum order quantities, and CAD requests can be found online. Visit www.nordsonmedical.com or contact Sales at sales@nordsonmedical.com.

LUER TO THREAD:

Female

PANEL MOUNTS:

Female Thread Style

XFTLL (-1 -6005 -9 -J1A)

Female Luer Thread Style with 1/4" Hex to 10-32 Special Tapered Thread



FTLLB210 (-1 -2 -6005 -9 -J1A)

Female Luer Thread Style Panel Mount 1/4-28 UNF to 200 Series Barb, 1/16" (1.6 mm) ID Tubing



KFTLL (-1 -6005 -9 -J1A)

Female Luer Thread Style with 1/4" Hex to 10-32 UNF Thread



FTLLB220 (-1 -2 -6005 -9 -J1A)

Female Luer Thread Style Panel Mount 1/4-28 UNF to 200 Series Barb, 3/32" (2.4 mm) ID Tubing



SFTLL (-1 -2 -4 -06 -6005 -6012 -9 -J1A)

Female Luer Thread Style with 5/16" Hex to 1/4-28 UNF Thread



FTLLB230 (-1 -2 -6005 -9 -J1A)

Female Luer Thread Style Panel Mount 1/4-28 UNF to 200 Series Barb, 1/8" (3.2 mm) ID Tubing



BSFTLL (-1 -6005 -J1A)

Female Luer Thread Style with 5/16" Hex to 1/4-28 UNF Bottom Sealing Thread



FTLLBMLRL (-1 -6005)

Female Luer Thread Style Panel Mount 1/4-28 UNF to Male Luer (May be used with separate rotating lock ring; FSLLR)



XFTL (-1 -6005 -9 -J1A)

Female Luer Lug Style with 1/4" Hex to 10-32 Special Tapered Thread



KFTL (-1 -6005 -9 -J1A)

Female Luer Lug Style with 1/4" Hex to 10-32 UNF Thread



SFTL (-1 -6005 -9)

Female Luer Lug Style with 5/16" Hex to 1/4-28 UNF Thread



18FTLL (-1 -6005 -6012 -J1A)

Female Luer Thread Style with 7/16" Hex to 1/8-27 NPT Thread



18LFTLL (-1 -4 -5 -6005 -6012 -J1A)

Female Luer Thread Style Elbow with 7/16" Hex to 1/8-27 NPT Thread

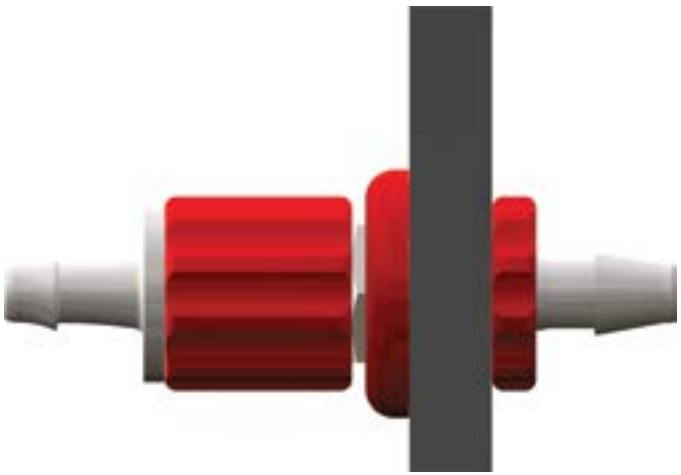

Fully Assembled Panel-Mounted Luer

Need More Details?

Additional threaded solutions are shown on **PG-88-97**. Check out all of our threaded style parts at www.nordsonmedical.com or contact Sales at sales@nordsonmedical.com.

Did You Know?

Nordson MEDICAL has an interactive PDF available online at www.nordsonmedical.com. Access part drawings, reference charts, data sheets, and more from just one location!

LUER FITTINGS

FTLB210 (-1 -6005 -9 -J1A)

Female Luer Lug Style Panel Mount 1/4-28 UNF to 200 Series Barb, 1/16" (1.6 mm) ID Tubing



FTLB220 (-1 -6005 -9 -J1A)

Female Luer Lug Style Panel Mount 1/4-28 UNF to 200 Series Barb, 3/32" (2.4 mm) ID Tubing



FTLB230 (-1 -6005 -9 -J1A)

Female Luer Lug Style Panel Mount 1/4-28 UNF to 200 Series Barb, 1/8" (3.2 mm) ID Tubing



MLRLB210 (-1 -6005)

Male Luer Panel Mount 10-32 UNF to 200 Series Barb, 1/16" (1.6 mm) ID Tubing, (May be used with separate rotating lock ring; FSLLR)



MLRLB220 (-1 -6005)

Male Luer Panel Mount 10-32 UNF to 200 Series Barb, 3/32" (2.4 mm) ID Tubing, (May be used with separate rotating lock ring; FSLLR)



MLRLB230 (-1 -6005)

Male Luer Panel Mount 1/4-28 UNF to 200 Series Barb, 1/8" (3.2 mm) ID Tubing, (May be used with separate rotating lock ring; FSLLR)



CCR (-1 -2 -3 -4 -5 -06 -07)

Color Coded Ring (For use with PMS, PMK, FTLLB or FTLB panel mount fittings)



CCLR (-1 -2 -3 -4 -5 -06 -07)

Color Coded Lock Ring (For use with PMS, PMK, FTLLB or FTLB panel mount fittings)



PMKN (-XO)

Panel Mount Nut 10-32 UNF with 3/8" Hex (For use with PMK panel mount fittings)



PMSN (-XO)

Panel Mount Nut 1/4-28 UNF with 7/16" Hex (For use with PMS, FTLLB, and FTLLB panel mount fittings)



LNS (-1 -2 -3 -4 -5 -06 -07 -6005 -81 -J1A)

1/4-28 UNF Panel Mount Lock Nut (For use with PMS, FTLLB or FTLB panel mount fittings)



Select the Correct Lock Nut for Your Panel Mount:

PART	Dimension A	Use Lock Nut
FTLLB Series	.255"	PMSN or LNS
FTLB Series	.255"	PMSN or LNS
FTLLBMLRL	.255"	PMSN or LNS
MLRLB210	.193"	PMKN
MLRLB220	.193"	PMKN
MLRLB230	.255"	PMSN or LNS

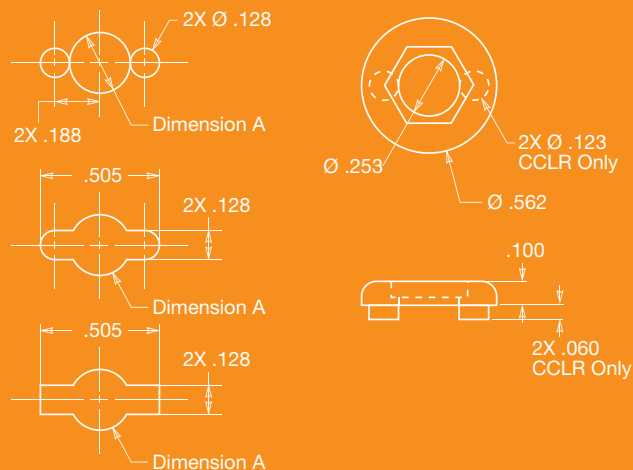

BLOOD PRESSURE

Fittings



BPF Series Female Bayonet Style Quick Connects
PG-68



Bayonet Male Cuff Connectors
PG-69



Bayonet Panel Mount Connectors
PG-69



Dinamap® Monitor Adapters
PG-69



Dinamap® Cuff Connectors
PG-70



BPL Series 1/4 Turn Cuff Connectors
PG-71



BPF Series

Blood Pressure Fittings

The BPF Series features an ergonomic design for simple one-handed operation. Easy to connect and disconnect to existing tubing, many locations are replacing their metal bayonet connectors with these light weight connectors. The BPF Series also works well with the new ISO 80369-5 limb cuff inflation standard compliant parts. The standard defines the bayonet as the only approved design.

BPF SERIES: Female Bayonet Style Quick Connect

BPF220 (-001) Black ABS Housing

Bayonet-Style Female Quick Connect Fitting, 200 Series Barb, 3/32" (2.4 mm) ID Tubing



works with...

BPM013	BPMB230
BPM240	BPMB240
BPM025	BPMB250
BPM035	BPAM
BPMMTLL	

BPF230 (-001) Black ABS Housing

Bayonet-Style Female Quick Connect Fitting, 200 Series Barb, 1/8" (3.2 mm) ID Tubing



works with...

BPM013	BPMB230
BPM240	BPMB240
BPM025	BPMB250
BPM035	BPAM
BPMMTLL	

BPF240 (-001) Black ABS Housing

Bayonet-Style Female Quick Connect Fitting, 200 Series Barb, 5/32" (4.0 mm) ID Tubing



works with...

BPM013	BPMB230
BPM240	BPMB240
BPM025	BPMB250
BPM035	BPAM
BPMMTLL	

BPF250 (-001) Black ABS Housing

Bayonet-Style Female Quick Connect Fitting, 200 Series Barb, 3/16" (4.8 mm) ID Tubing



works with...

BPM013	BPMB230
BPM240	BPMB240
BPM025	BPMB250
BPM035	BPAM
BPMMTLL	

BLOOD PRESSURE:
Bayonet Male Cuff Connectors

BPM013 (-1)

Blood Pressure Monitor Bayonet Connector to 500 Series Barb, 80369-5 Compliant, 1/8" (3.2 mm) ID Tubing



BPM240 (-1)

Blood Pressure Monitor Bayonet Connector to 200 Series Barb, 80369-5 Compliant, 5/32" (4.0 mm) ID Tubing



BPM025 (-1)

Blood Pressure Monitor Bayonet Connector to 500 Series Barb, 80369-5 Compliant, 5/32" (4.0 mm) ID Tubing



BPM035 (-1)

Blood Pressure Monitor Bayonet Connector to 500 Series Barb, 80369-5 Compliant, 3/16" (4.8 mm) ID Tubing



BPMMTLL (-1 -5)

Blood Pressure Monitor Bayonet Connector to Male Luer Integral Lock Ring



works with...



BLOOD PRESSURE:
Bayonet Panel Mount Connectors

BPMB230 (-1)

Blood Pressure Monitor Bayonet Panel Mount Connector to 200 Series Barb, 1/4-28 UNF Thread, 1/8" (3.2 mm) ID Tubing



works with...



BPMB240 (-1)

Blood Pressure Monitor Bayonet Panel Mount Connector to 200 Series Barb, 5/16-24 UNF Thread, 5/32" (4.0 mm) ID Tubing



works with...



BPMB250 (-1)

Blood Pressure Monitor Bayonet Panel Mount Connector to 200 Series Barb, 3/8-24 UNF Thread, 3/16" (4.8 mm) ID Tubing



works with...



BLOOD PRESSURE:
Panel Mount Nuts

PMSN (-XO)

Panel Mount Nut 1/4-28 UNF with 7/16" Hex (For use with BPMB230)



PM3N (-XO)

Panel Mount Nut 5/16-24 UNF Zinc-Plated Class 2 Steel Nut (For use with BPMB240)



PM2N (-XO)

Panel Mount Nut 3/8-24 UNF Zinc-Plated Class 2 Steel Nut (For use with BPMB250)



BLOOD PRESSURE:
Dinamap® Monitor Adapters

BPAM (-001) Black Nylon over White Nylon

Blood Pressure Monitor Bayonet Connector to Internal 5/16-24 UNF Thread and O-Ring



works with...



BPA013 (-001) Black Nylon over White Nylon

Blood Pressure Adapter with Internal 5/16-24 UNF Thread and O-Ring to 500 Series Barb, 1/8" (3.2 mm) ID Tubing



BPA025 (-001) Black Nylon over White Nylon

Blood Pressure Adapter with Internal 5/16-24 UNF Thread and O-Ring to 500 Series Barb, 5/32" (4.0 mm) ID Tubing



BPA035 (-001) Black Nylon over White Nylon

Blood Pressure Adapter with Internal 5/16-24 UNF Thread and O-Ring to 500 Series Barb, 3/16" (4.8 mm) ID Tubing



BPA055 (-001) Black Nylon over White Nylon

Blood Pressure Adapter with Internal 5/16-24 UNF Thread and O-Ring to 500 Series Barb, 1/4" (6.4 mm) ID Tubing



BLOOD PRESSURE

BLOOD PRESSURE: Dinamap® Cuff Connectors

BPCL220 (-10 -81)

Blood Pressure Adapter with 5/16-24 UNF Thread and 6% Taper to 200 Series Barb, 3/32" (2.4 mm) ID Tubing



BPC220 (-10)

Blood Pressure Adapter with 5/16-24 UNF Thread to 200 Series Barb, 3/32" (2.4 mm) ID Tubing



BPCL230 (-10 -81)

Blood Pressure Adapter with 5/16-24 UNF Thread and 6% Internal Taper to 200 Series Barb, 1/8" (3.2 mm) ID Tubing



BPC230 (-10)

Blood Pressure Adapter with 5/16-24 UNF Thread to 200 Series Barb, 1/8" (3.2 mm) ID Tubing



BPCL240 (-10 -81)

Blood Pressure Adapter with 5/16-24 UNF Thread and 6% Internal Taper to 200 Series Barb, 5/32" (4.0 mm) ID Tubing

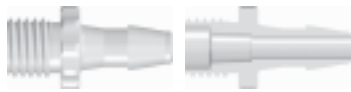

BPC240 (-10)

Blood Pressure Adapter with 5/16-24 UNF Thread to 200 Series Barb, 5/32" (4.0 mm) ID Tubing



BPCL025 (-10)

Blood Pressure Adapter with 5/16-24 UNF Thread 6% Internal Taper to 500 Series Barb, 5/32" (4.0 mm) ID Tubing

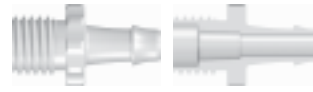

BPC025 (-10)

Blood Pressure Adapter with 5/16-24 UNF Thread to 500 Series Barb, 5/32" (4.0 mm) ID Tubing



BPCL250 (-10 -81)

Blood Pressure Adapter with 5/16-24 UNF Thread and 6% Internal Taper to 200 Series Barb, 3/16" (4.8 mm) ID Tubing



BPC250 (-10)

Blood Pressure Adapter with 5/16-24 UNF Thread to 200 Series Barb, 3/16" (4.8 mm) ID Tubing



CF229 (-1)

Neonatal Blood Pressure Slip Fit (non luer) with 200 Series Barb, 3/32" (2.4 mm) ID Tubing



CF230 (-1)

Neonatal Blood Pressure Slip Fit (non luer) with 200 Series Barb, 5/32" (4.0 mm) ID Tubing



BLOOD PRESSURE

Did You Know?

Nordson MEDICAL has an interactive PDF available online at www.nordsonmedical.com. Access part drawings, reference charts, data sheets, and more from just one location!

BPL Series

Blood Pressure Fittings

The BPL Series quick connect fittings offers superior ergonomics - a requirement for many designers in their effort to accommodate end users. The BPL's ease-of-use stems largely from a winged male fitting and Nordson MEDICAL's patented 10-point grip, making the quarter-turn connection simple and easy to accomplish. A solid snap, that can be both heard and felt, will then reassure the end user that a secure fit has been made.

Another unique characteristic of the BPL Series is the true tube stop on the rotating half of the two connectors. This allows tubing to be fully assembled onto the barb without its edge pushing against the body of the connector.

Features & Benefits:

Ergonomic Wing-Grip Design

- Easier to connect and disconnect than market similars
- 360° of tubing rotation

Quarter-Turn Design with Closure Feedback

- Positive reinforcement of secure connection

Sizes to Fit 1/8" (3.2 mm) and 5/32" (4.0 mm) ID tubing

- Fits almost all cuffs
- 5/32" hose barb perfectly fits most common cuff tube size

200 Series Single Barbs

- Ease of assembly
- Enhanced resistance to tube pulloff

Medical Grade ABS Material (Fluid Path)

- Withstands bulk sterilization processes
- Holds up under demanding application conditions

Acetal (Wing-Grip Shroud)

- Added strength

BPLF230 (-8012)

Quarter-turn Female Blood Pressure Cuff Connector to 200 Series Barb, 1/8" (3.2 mm) Tubing ID



BPLF240 (-8012)

Quarter-turn Female Blood Pressure Cuff Connector to 200 Series Barb, 5/32" (4.0 mm) Tubing ID



BPLM230 (-001) White ABS, White Acetal, Buna-N O-Ring

Quarter-turn Male Blood Pressure Cuff Connector to 200 Series Barb, 1/8" (3.2 mm) Tubing ID



BPLM240 (-001) White ABS, White Acetal, Buna-N O-Ring

Quarter-turn Male Blood Pressure Cuff Connector to 200 Series Barb, 5/32" (4.0 mm) Tubing ID

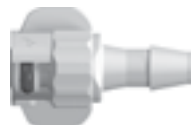

BLOOD PRESSURE

Need Samples for Evaluation?

You can call to request most of our standard product in quantities of 5, or less, for free application evaluation.
+1 (970) 267-5200 Toll Free: (888) 404-5837

Part Drawings Online!

Nordson MEDICAL provides dimensional drawings available for download for all of its fittings.
www.nordsonmedical.com

TUBE-TO-TUBE

Connectors



Straight Throughs
PG-73



Straight Through Reducers
PG-75

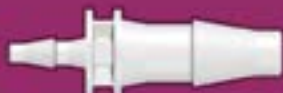

Elbows
PG-78



Elbow Reducers
PG-79



Tees
PG-80



Tee Reducers
PG-81



Ys
PG-83



Multiports
PG-84



Press-In Plugs
PG-86



Ultrasonically Weldable Barbs
PG-87



Panel Mounts & Accessories
PG-87



Nordson MEDICAL offers barbed tube fittings and tubing connectors in sizes ranging from 1/16" (1.6 mm) to 1" (25.4 mm) tubing ID in over 100 separate configurations in nylon, polypropylene, polycarbonate and PVDF, with other engineering resins available on special order. Available barbed fitting styles include straight tube connectors, elbow fittings, tee fittings, crosses, Y (wye) connectors, multi-port connectors, and multiple straight, elbow and tee reducer combinations.

Several barb styles are offered to provide designers the widest range of assembly forces, pulloff resistance and blowoff resistance – without the need for clamps. Review the descriptions for each of the styles to determine what's best for your application.

Small Bore Barb Styles

Tube ID	Classic	200 Series	400 Series	500 Series
1/16" (1.6 mm)	X	X	X	X
3/32" (2.4 mm)	X	X	X	X
1/8" (3.2 mm)	X	X	X	X
5/32" (4.0 mm)	X	X	X	X
3/16" (4.8 mm)	X	X	X	X
1/4" (6.4 mm)	X	X	X	X
5/16" (8.0 mm)				X

Large Bore Barb Styles

Tube ID	500 Series	600 Series	900 Series
3/8" (9.5 mm)	X	X	X
1/2" (12.7 mm)	X	X	X
5/8" (16.0 mm)	X	X	
3/4" (19.0 mm)	X	X	
1" (25.4 mm)	X	X	

TUBE-TO-TUBE: Straight Through

AA (-1 -2 -6005 -9 -J1A)

Straight Through Connector with Classic Series Barbs, 1/16" (1.6 mm) ID Tubing



N210 (-1 -2 -6005 -9 -J1A)

Straight Through Connector with 200 Series Barbs, 1/16" (1.6 mm) ID Tubing



N410 (-1 -2 -6005 -J1A)

Straight Through Connector with 400 Series Barbs, 1/16" (1.6 mm) ID Tubing



N004 (-1 -2 -6005 -9 -J1A)

Straight Through Connector with 500 Series Barbs, 1/16" (1.6 mm) ID Tubing



DD (-1 -2 -6005 -9 -J1A)

Straight Through Connector with Classic Series Barbs, 3/32" (2.4 mm) ID Tubing



N220 (-1 -2 -6005 -9 -9002 -J1A)

Straight Through Connector with 200 Series Barbs, 3/32" (2.4 mm) ID Tubing



N420 (-1 -2 -6005 -J1A)

Straight Through Connector with 400 Series Barbs, 3/32" (2.4 mm) ID Tubing



N007 (-1 -2 -6005 -9 -J1A)

Straight Through Connector with 500 Series Barbs, 3/32" (2.4 mm) ID Tubing



CC (-1 -2 -6005 -9 -J1A)

Straight Through Connector with Classic Series Barbs, 1/8" (3.2 mm) ID Tubing



N230 (-1 -2 -3 -5 -6005 -9 -J1A)

Straight Through Connector with 200 Series Barbs, 1/8" (3.2 mm) ID Tubing



N430 (-1 -2 -6005 -J1A)

Straight Through Connector with 400 Series Barbs, 1/8" (3.2 mm) ID Tubing



N013 (-1 -2 -6005 -9 -J1A -9002)

Straight Through Connector with 500 Series Barbs, 1/8" (3.2 mm) ID Tubing



4040 (-1 -2 -6005 -9 -J1A)

Straight Through Connector with Classic Series Barbs, 5/32" (4.0 mm) ID Tubing



N440 (-1 -2 -5 -6005 -9 -J1A)

Straight Through Connector with 400 Series Barbs, 5/32" (4.0 mm) ID Tubing



N025 (-1 -2 -6005 -9 -J1A)

Straight Through Connector with 500 Series Barbs, 5/32" (4.0 mm) ID Tubing



Need Samples for Evaluation?

You can call to request most of our standard product in quantities of 5, or less, for free application evaluation.

+1 (970) 267-5200 Toll Free: (888) 404-5837

TUBE-TO-TUBE: Straight Through

5050 (-1 -2 -6005 -9 -9002 -J1A)

Straight Through Connector with Classic Series Barbs, 3/16" (4.8 mm) ID Tubing



N035 (-1 -2 -6005 -9 -J1A)

Straight Through Connector with 500 Series Barbs, 3/16" (4.8 mm) ID Tubing



6060 (-1 -2 -6005 -9 -9002 -J1A)

Straight Through Connector with Classic Series Barbs, 1/4" (6.4 mm) ID Tubing



N055 (-1 -2 -6005 -9 -J1A)

Straight Through Connector with 500 Series Barbs, 1/4" (6.4 mm) ID Tubing



N065 (-1 -2 -6005 -9 -J1A)

Straight Through Connector with 500 Series Barbs, 5/16" (8 mm) ID Tubing



LARGE TUBE-TO-TUBE: Straight Through



Reference part shown: N670

Due to size we are not able to display all large Tube-To-Tube connectors. Please see www.nordsonmedical.com for part reference. Minimum package quantities vary by tube IDs, please verify minimum package sizes when placing orders.

N070 (-0 -6005 -9)

Straight Through Connector with 500 Series Barbs, 3/8" (9.5 mm) ID Tubing

N670 (-6005 -9 -J1A)

Straight Through Connector with 600 Series Barbs, 3/8" (9.5 mm) ID Tubing

N970 (-9)

Straight Through Connector with 900 Series Barbs, 3/8" (9.5 mm) ID Tubing

N080 (-0 -6005 -9)

Straight Through Connector with 500 Series Barbs, 1/2" (12.7 mm) ID Tubing

N680 (-6005 -9 -J1A)

Straight Through Connector with 600 Series Barbs, 1/2" (12.7 mm) ID Tubing

N975 (-9)

Straight Through Connector with 900 Series Barbs, 1/2" (12.7 mm) ID Tubing

N090 (-0 -6005 -9)

Straight Through Connector with 500 Series Barbs, 5/8" (16.0 mm) ID Tubing

N690 (-0 -6005 -9)

Straight Through Connector with 600 Series Barbs, 5/8" (16.0 mm) ID Tubing

N100 (-0 -6005)

Straight Through Connector with 500 Series Barbs, 3/4" (19.0 mm) ID Tubing

N6100 (-6005)

Straight Through Connector with 600 Series Barbs, 3/4" (19.0 mm) ID Tubing

N110 (-0 -6005)

Straight Through Connector with 500 Series Barbs, 1" (25.4 mm) ID Tubing

N6110 (-6005)

Straight Through Connector with 600 Series Barbs, 1" (25.4 mm) ID Tubing

Part Drawings Online!

Nordson MEDICAL provides dimensional drawings available for download for all of its fittings.

www.nordsonmedical.com

AD (-1 -2 -6005 -9 -J1A)

Straight Through Reduction Connector with Classic Series Barbs, 3/32" (2.4 mm) and 1/16" (1.6 mm) ID Tubing



DC (-1 -2 -6005 -9)

Straight Through Reduction Connector with Classic Series Barbs, 1/8" (3.2 mm) and 3/32" (2.4 mm) ID Tubing



N220/210 (-1 -2 -6005 -9 -J1A)

Straight Through Reduction Connector with 200 Series Barbs, 3/32" (2.4 mm) and 1/16" (1.6 mm) ID Tubing



N230/220 (-1 -2 -6005 -07 -9 -J1A)

Straight Through Reduction Connector with 200 Series Barbs, 1/8" (3.2 mm) and 3/32" (2.4 mm) ID Tubing



N420/410 (-1 -2 -6005 -10 -J1A)

Straight Through Reduction Connector with 400 Series Barbs, 3/32" (2.4 mm) and 1/16" (1.6 mm) ID Tubing



N430/420 (-1 -2 -6005 -6012 -J1A)

Straight Through Reduction Connector with 400 Series Barbs, 1/8" (3.2 mm) and 3/32" (2.4 mm) ID Tubing



N007/004 (-1 -2 -6005 -9 -J1A)

Straight Through Reduction Connector with 500 Series Barbs, 3/32" (2.4 mm) and 1/16" (1.6 mm) ID Tubing



N013/007 (-1 -2 -6005 -6012 -9 -9002 -J1A)

Straight Through Reduction Connector with 500 Series Barbs, 1/8" (3.2 mm) and 3/32" (2.4 mm) ID Tubing



AC (-0 -1 -2 -6005 -9 -J1A)

Straight Through Reduction Connector with Classic Series Barbs, 1/8" (3.2 mm) and 1/16" (1.6 mm) ID Tubing



1040 (-1 -2 -6005 -9 -J1A)

Straight Through Reduction Connector with Classic Series Barbs, 5/32" (4.0 mm) and 1/16" (1.6 mm) ID Tubing



N230/210 (-1 -2 -6005 -9 -J1A)

Straight Through Reduction Connector with 200 Series Barbs, 1/8" (3.2 mm) and 1/16" (1.6 mm) ID Tubing



N025/004 (-1 -2 -6005 -9 -J1A)

Straight Through Reduction Connector with 500 Series Barbs, 5/32" (4.0 mm) and 1/16" (1.6 mm) ID Tubing



N430/410 (-1 -2 -6005 -J1A)

Straight Through Reduction Connector with 400 Series Barbs, 1/8" (3.2 mm) and 1/16" (1.6 mm) ID Tubing



2040 (-1 -2 -6005 -9 -J1A)

Straight Through Reduction Connector with Classic Series Barbs, 5/32" (4.0 mm) and 3/32" (2.4 mm) ID Tubing



N013/004 (-1 -2 -6005 -9 -J1A)

Straight Through Reduction Connector with 500 Series Barbs, 1/8" (3.2 mm) and 1/16" (1.6 mm) ID Tubing



N025/007 (-1 -2 -6005 -6012 -9 -J1A)

Straight Through Reduction Connector with 500 Series Barbs, 5/32" (4.0 mm) and 3/32" (2.4 mm) ID Tubing



TUBE-TO-TUBE: Straight Through Reducer

3040 (-1 -2 -6005 -9 -J1A)

Straight Through Reduction Connector with Classic Series Barbs, 5/32" (4.0 mm) and 1/8" (3.2 mm) ID Tubing



4050 (-1 -2 -6005 -9 -J1A)

Straight Through Reduction Connector with Classic Series Barbs, 3/16" (4.8 mm) and 5/32" (4.0 mm) ID Tubing



N025/013 (-1 -2 -6005 -9 -J1A)

Straight Through Reduction Connector with 500 Series Barbs, 3/32" (4.0 mm) and 1/8" (3.2 mm) ID Tubing



N035/025 (-1 -2 -6005 -9 -J1A)

Straight Through Reduction Connector with 500 Series Barbs, 3/16" (4.8 mm) and 5/32" (4.0 mm) ID Tubing



1050 (-1 -2 -6005 -9 -J1A)

Straight Through Reduction Connector with Classic Series Barbs, 3/16" (4.8 mm) and 1/16" (1.6 mm) ID Tubing



3060 (-1 -2 -6005 -9 -J1A -J1A2)

Straight Through Reduction Connector with Classic Series Barbs, 1/4" (6.4 mm) and 1/8" (3.2 mm) ID Tubing



2050 (-1 -2 -6005 -9 -J1A)

Straight Through Reduction Connector with Classic Series Barbs, 3/16" (4.8 mm) and 3/32" (2.4 mm) ID Tubing



N055/013 (-1 -2 -6005 -9 -J1A)

Straight Through Reduction Connector with 500 Series Barbs, 1/4" (6.4 mm) and 1/8" (3.2 mm) ID Tubing



N035/007 (-1 -2 -6005 -9 -J1A)

Straight Through Reduction Connector with 500 Series Barbs, 3/16" (4.8 mm) and 3/32" (2.4 mm) ID Tubing



4060 (-1 -2 -6005 -9 -J1A)

Straight Through Reduction Connector with Classic Series Barbs, 1/4" (6.4 mm) and 5/32" (4.0 mm) ID Tubing



3050 (-1 -2 -5 -6005 -81 -9 -9002 -J1A)

Straight Through Reduction Connector with Classic Series Barbs, 3/16" (4.8 mm) and 1/8" (3.2 mm) ID Tubing



N055/025 (-1 -2 -6005 -9 -J1A)

Straight Through Reduction Connector with 500 Series Barbs, 1/4" (6.4 mm) and 5/32" (4.0 mm) ID Tubing



N035/013 (-1 -2 -6005 -81 -9 -J1A)

Straight Through Reduction Connector with 500 Series Barbs, 3/16" (4.8 mm) and 1/8" (3.2 mm) ID Tubing



TUBE-TO-TUBE
FITTINGS

Did You Know?

Nordson MEDICAL has an interactive PDF available online at www.nordsonmedical.com. Access part drawings, reference charts, data sheets, and more from just one location!

TUBE-TO-TUBE:
Straight Through Reducer

5060 (-1 -2 -6005 -9 -9002 -J1A)
Straight Through Reduction Connector with Classic Series Barbs,
1/4" (6.4 mm) and 3/16" (4.8 mm) ID Tubing



N055/035 (-1 -2 -6005 -9 -J1A)
Straight Through Reduction Connector with 500 Series Barbs,
1/4" (6.4 mm) and 3/16" (4.8 mm) ID Tubing



N065/025 (-1 -2 -6005 -9 -J1A)
Straight Through Reduction Connector with 500 Series Barbs,
5/16" (8.0 mm) and 5/32" (4.0 mm) ID Tubing



N065/035 (-1 -2 -6005 -9 -J1A)
Straight Through Reduction Connector with 500 Series Barbs,
5/16" (8.0 mm) and 3/16" (4.8 mm) ID Tubing



N065/055 (-1 -2 -6005 -9 -J1A)
Straight Through Reduction Connector with 500 Series Barbs,
5/16" (8.0 mm) and 1/4" (6.4 mm) ID Tubing



LARGE TUBE-TO-TUBE:
Straight Through Reducer



Reference part shown: **N070/013**

Due to size we are not able to display all large Tube-To-Tube connectors. Please see www.nordsonmedical.com for part reference. Minimum package quantities vary by tube IDs, please verify minimum package sizes when placing orders.

N070/013 (-0 -6005 -9 -9002 -J1A)
Straight Through Reduction Connector with 500 Series Barbs, 3/8" (9.5 mm) and 1/8" (3.2 mm) ID Tubing

N070/055 (-0 -6005 -9)
Straight Through Reduction Connector with 500 Series Barbs, 3/8" (9.5 mm) and 1/4" (6.4 mm) ID Tubing

N670/655 (-6005 -9 -J1A)
Straight Through Reduction Connector with 600 Series Barbs, 3/8" (9.5 mm) and 1/4" (6.4 mm) ID Tubing

N080/055 (-0 -6005 -9)
Straight Through Reduction Connector with 500 Series Barbs, 1/2" (12.7 mm) and 1/4" (6.4 mm) ID Tubing

N680/655 (-6005 -9 -J1A)
Straight Through Reduction Connector with 600 Series Barbs, 1/2" (12.7 mm) and 1/4" (6.4 mm) ID Tubing

N080/070 (-0 -6005 -9)
Straight Through Reduction Connector with 500 Series Barbs, 1/2" (12.7 mm) and 3/8" (9.5 mm) ID Tubing

N680/670 (-6005 -9)
Straight Through Reduction Connector with 600 Series Barbs, 1/2" (12.7 mm) and 3/8" (9.5 mm) ID Tubing

N090/055 (-0 -6005)
Straight Through Reduction Connector with 500 Series Barbs, 5/8" (16.0 mm) and 1/4" (6.4 mm) ID Tubing

N690/655 (-6005 -9)
Straight Through Reduction Connector with 600 Series Barbs, 5/8" (16.0 mm) and 1/4" (6.4 mm) ID Tubing

N090/070 (-0 -6005)
Straight Through Reduction Connector with 500 Series Barbs, 5/8" (16.0 mm) and 3/8" (9.5 mm) ID Tubing

N690/670 (-6005 -9)
Straight Through Reduction Connector with 600 Series Barbs, 5/8" (16.0 mm) and 3/8" (9.5 mm) ID Tubing

N6100/670 (-6005)
Straight Through Reduction Connector with 600 Series Barbs, 3/4" (19 mm) and 3/8" (9.5 mm) ID Tubing

N100/080 (-0 -6005)
Straight Through Reduction Connector with 500 Series Barbs, 3/4" (19.0 mm) and 1/2" (12.7 mm) ID Tubing

N6100/680 (-6005)
Straight Through Reduction Connector with 600 Series Barbs, 3/4" (19 mm) and 1/2" (12.7 mm) ID Tubing

N6110/680 (-6005)
Straight Through Reduction Connector with 600 Series Barbs, 1" (25.4 mm) and 1/2" (12.7 mm) ID Tubing

N110/100 (-0 -6005)
Straight Through Reduction Connector with 500 Series Barbs, 1" (25.4 mm) and 3/4" (19.0 mm) ID Tubing

N6110/6100 (-6005 -9)
Straight Through Reduction Connector with 600 Series Barbs, 1" (25.4 mm) and 3/4" (19.0 mm) ID Tubing

TUBE-TO-TUBE:
Elbow

L10 (-1 -2 -6005 -J1A)
Elbow Connector with Classic Series Barbs, 1/16" (1.6 mm) ID Tubing



L430 (-1 -2 -6005 -J1A)
Elbow Connector with 400 Series Barbs, 1/8" (3.2 mm) ID Tubing



L210 (-1 -2 -6005 -9 -J1A)
Elbow Connector with 200 Series Barbs, 1/16" (1.6 mm) ID Tubing



L40 (-1 -2 -6005 -J1A)
Elbow Connector with Classic Series Barbs, 5/32" (4.0 mm) ID Tubing



L410 (-1 -2 -6005 -J1A)
Elbow Connector with 400 Series Barbs, 1/16" (1.6 mm) ID Tubing



L20 (-1 -2 -6005 -J1A)
Elbow Connector with Classic Series Barbs, 3/32" (2.4 mm) ID Tubing



L440 (-2)
Elbow Connector with 400 Series Barbs, 5/32" (4.0 mm) ID Tubing



L220 (-1 -2 -6005 -6012 -9 -9002 -J1A)
Elbow Connector with 200 Series Barbs, 3/32" (2.4 mm) ID Tubing



L50 (-1 -2 -6005 -J1A)
Elbow Connector with Classic Series Barbs, 3/16" (4.8 mm) ID Tubing



TUBE-TO-TUBE
FITTINGS

L420 (-1 -2 -6005 -J1A)
Elbow Connector with 400 Series Barbs, 3/32" (2.4 mm) ID Tubing



L60 (-1 -2 -6005 -J1A)
Elbow Connector with Classic Series Barbs, 1/4" (6.4 mm) ID Tubing



L30 (-1 -2 -6005 -J1A)
Elbow Connector with Classic Series Barbs, 1/8" (3.2 mm) ID Tubing



L230 (-1 -2 -6005 -6012 -9 -J1A)
Elbow Connector with 200 Series Barbs, 1/8" (3.2 mm) ID Tubing



Need More Details?
Part drawings, minimum order quantities, and CAD requests can be found online. Visit www.nordsonmedical.com or contact Sales at sales@nordsonmedical.com.



Reference part shown: **L070**

Due to size we are not able to display all large Tube-To-Tube connectors. Please see www.nordsonmedical.com for part reference. Minimum package quantities vary by tube IDs, please verify minimum package sizes when placing orders.

L070 (-0 -6005)

Elbow Connector with 500 Series Barbs, 3/8" (9.5 mm) ID Tubing

L970 (-9)

Elbow Connector with 900 Series Barbs, 3/8" (9.5 mm) ID Tubing

L080 (-0 -6005)

Elbow Connector with 500 Series Barbs, 1/2" (12.7 mm) ID Tubing

L975 (-9)

Elbow Connector with 900 Series Barbs, 1/2" (12.7 mm) ID Tubing

L090 (-0 -6005)

Elbow Connector with 500 Series Barbs, 5/8" (16.0 mm) ID Tubing

L100 (-0 -6005)

Elbow Connector with 500 Series Barbs, 3/4" (19.0 mm) ID Tubing

L110 (-0 -6005)

Elbow Connector with 500 Series Barbs, 1" (25.4 mm) ID Tubing

L6110 (-6005)

Elbow Connector with 600 Series Barbs, 1" (25.4 mm) ID Tubing

CF494 (-6 -6005)

Low-profile Elbow Connector with Custom 600 Series Barbs, 1" (25.4 mm) ID Tubing

L220/210 (-1 -2 -6005 -9 -J1A)

Elbow Reduction Connector with 200 Series Barbs, 3/32" (2.4 mm) and 1/16" (1.6 mm) ID Tubing



L420/410 (-1 -2 -6005 -J1A)

Elbow Reduction Connector with 400 Series Barbs, 3/32" (2.4 mm) and 1/16" (1.6 mm) ID Tubing



L230/210 (-1 -2 -6005 -9 -J1A)

Elbow Reduction Connector with 200 Series Barbs, 1/8" (3.2 mm) and 1/16" (1.6 mm) ID Tubing



L430/410 (-1 -2 -6005 -J1A)

Elbow Reduction Connector with 400 Series Barbs, 1/8" (3.2 mm) and 1/16" (1.6 mm) ID Tubing



L230/220 (-1 -2 -6005 -9 -J1A)

Elbow Reduction Connector with 200 Series Barbs, 1/8" (3.2 mm) and 3/32" (2.4 mm) ID Tubing



L430/420 (-1 -2 -6005 -J1A)

Elbow Reduction Connector with 400 Series Barbs, 1/8" (3.2 mm) and 3/32" (2.4 mm) ID Tubing



L430/220 (-9002)

Elbow Reduction Connector with a 400 Series Barb, 1/8" (3.2 mm) and a 200 Series Barb, 3/32" (2.4 mm) ID Tubing



LARGE TUBE-TO-TUBE: Elbow Reducer



Reference part shown: **L070/055**

Due to size we are not able to display all large Tube-To-Tube connectors. Please see www.nordsonmedical.com for part reference. Minimum package quantities vary by tube IDs, please verify minimum package sizes when placing orders.

L070/055 (-0 -6005)
Elbow Reduction Connector with 500 Series Barbs, 3/8" (9.5 mm) and 1/4" (6.4 mm) ID Tubing

L080/070 (-0 -6005)
Elbow Reduction Connector with 500 Series Barbs, 1/2" (12.7 mm) and 3/8" (9.5 mm) ID Tubing

L100/080 (-0 -6005)
Elbow Reduction Connector with 500 Series Barbs, 3/4" (19.0 mm) and 1/2" (12.7 mm) ID Tubing

L110/100 (-0 -6005)
Elbow Reduction Connector with 500 Series Barbs, 1" (25.4 mm) and 3/4" (19.0 mm) ID Tubing

TUBE-TO-TUBE: Tee

T10 (-1 -2 -6005 -J1A)
Tee Connector with Classic Series Barbs, 1/16" (1.6 mm) ID Tubing



T210 (-1 -2 -6005 -9 -J1A)
Tee Connector with 200 Series Barbs, 1/16" (1.6 mm) ID Tubing



T410 (-1 -2 -6005 -J1A)
Tee Connector with 400 Series Barbs, 1/16" (1.6 mm) ID Tubing



T20 (-1 -2 -6005 -J1A)
Tee Connector with Classic Series Barbs, 3/32" (2.4 mm) ID Tubing



T220 (-1 -2 -6005 -6012 -9 -J1A)
Tee Connector with 200 Series Barbs, 3/32" (2.4 mm) ID Tubing



TUBE-TO-TUBE: Tee

T420 (-1 -2 -6005 -J1A)
Tee Connector with 400 Series Barbs, 3/32" (2.4 mm) ID Tubing



T30 (-1 -2 -6005 -9 -J1A)
Tee Connector with Classic Series Barbs, 1/8" (3.2 mm) ID Tubing



T230 (-1 -2 -5 -6005 -6012 -9 -J1A)
Tee Connector with 200 Series Barbs, 1/8" (3.2 mm) ID Tubing



T430 (-1 -2 -6005 -9002 -J1A)
Tee Connector with 400 Series Barbs, 1/8" (3.2 mm) ID Tubing



T013 (-6005)
Tee Connector with 500 Series Barbs, 1/8" (3.2 mm) ID Tubing



T40 (-1 -2 -6005 -J1A)
Tee Connector with Classic Series Barbs, 5/32" (4 mm) ID Tubing



T250 (-1 -2 -6005 -9 -J1A)
Tee Connector with 200 Series Barbs, 3/16" (4.8 mm) ID Tubing



T60 (-1 -2 -6005 -9 -J1A)
Tee Connector with Classic Series Barbs, 1/4" (6.4 mm) ID Tubing



TUBE-TO-TUBE
FITTINGS

TUBE-TO-TUBE:

Tee

T055 (-6005)

Tee Connector with 500 Series Barbs, 1/4" (6.4 mm) ID Tubing



LARGE TUBE-TO-TUBE:

Tee

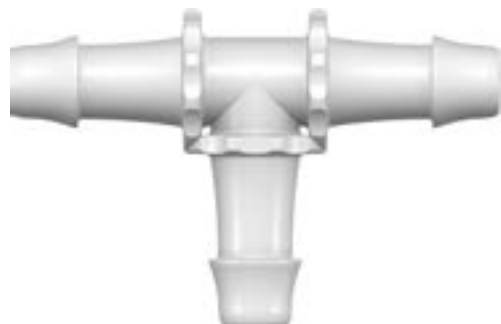

Reference part shown: T070

Due to size we are not able to display all large Tube-To-Tube connectors. Please see www.nordsonmedical.com for part reference. Minimum package quantities vary by tube IDs, please verify minimum package sizes when placing orders.

T070 (-0 -6005 -9)

Tee Connector with 500 Series Barbs, 3/8" (9.5 mm) ID Tubing

T670 (-1 -6005 -9 -J1A)

Tee Connector with 600 Series Barbs, 3/8" (9.5 mm) ID Tubing

T970 (-9)

Tee Connector with 900 Series Barbs, 3/8" (9.5 mm) ID Tubing

T080 (-0 -6005 -9)

Tee Connector with 500 Series Barbs, 1/2" (12.7 mm) ID Tubing

T680 (-6005 -9 -J1A)

Tee Connector with 600 Series Barbs, 1/2" (12.7 mm) ID Tubing

T975 (-9)

Tee Connector with 900 Series Barbs, 1/2" (12.7 mm) ID Tubing

T690 (-6005 -9)

Tee Connector with 600 Series Barbs, 5/8" (16.0 mm) ID Tubing

T100 (-0 -6005 -9)

Tee Connector with 500 Series Barbs, 3/4" (19.0 mm) ID Tubing

T6100 (-6005)

Tee Connector with 600 Series Barbs, 3/4" (19.0 mm) ID Tubing

T110 (-0 -6005)

Tee Connector with 500 Series Barbs, 1" (25.4 mm) ID Tubing

T6110 (-6005)

Tee Connector with 600 Series Barbs, 1" (25.4 mm) ID Tubing

TUBE-TO-TUBE:

Tee Reducer

T410/420 (-1 -2 -6005 -J1A)

Tee Reduction Connector with 400 Series Barbs, 1/16" (1.6 mm) and 3/32" (2.4 mm) ID Tubing



← 3/32"

T210/230 (-1 -2 -6005 -9 -J1A)

Tee Reduction Connector with 200 Series Barbs, 1/16" (1.6 mm) and 1/8" (3.2 mm) ID Tubing



← 1/8"

T410/430 (-1 -2 -6005 -J1A)

Tee Reduction Connector with 400 Series Barbs, 1/16" (1.6 mm) and 1/8" (3.2 mm) ID Tubing

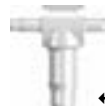

← 1/8"

T220/210 (-1 -2 -6005 -9 -J1A)

Tee Reduction Connector with 200 Series Barbs, 3/32" (2.4 mm) and 1/16" (1.6 mm) ID Tubing



← 1/16"

T220R210 (-1 -2 -6005 -9 -J1A)

Tee Reduction Connector with 200 Series Barbs, 3/32" (2.4 mm) and 1/16" (1.6 mm) ID Tubing



↑ 1/16"

T420/410 (-1 -2 -6005 -J1A)

Tee Reduction Connector with 400 Series Barbs, 3/32" (2.4 mm) and 1/16" (1.6 mm) ID Tubing

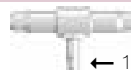

← 1/16"

T420R410 (-1 -2 -6005 -J1A)

Tee Reduction Connector with 400 Series Barbs, 3/32" (2.4 mm) and 1/16" (1.6 mm) ID Tubing



↑ 1/16"

T210/220 (-1 -2 -6005 -9 -J1A)

Tee Reduction Connector with 200 Series Barbs, 3/32" (2.4 mm) and 1/16" (1.6 mm) ID Tubing



← 3/32"

T220/230 (-1 -2 -6005 -9 -J1A)

Tee Reduction Connector with 200 Series Barbs, 3/32" (2.4 mm) and 1/8" (3.2 mm) ID Tubing

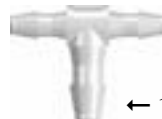

← 1/8"

T420/430 (-1 -2 -6005 -J1A)

Tee Reduction Connector with 400 Series Barbs, 3/32" (2.4 mm) and 1/8" (3.2 mm) ID Tubing



← 1/8"

TUBE-TO-TUBE: Tee Reducer

T230/210 (-1 -2 -6005 -9 -J1A)
Tee Reduction Connector with 200 Series Barbs, 1/8" (3.2 mm) and 1/16" (1.6 mm) ID Tubing



T230R210 (-1 -2 -6005 -9 -J1A)
Tee Reduction Connector with 200 Series Barbs, 1/8" (3.2 mm) and 1/16" (1.6 mm) ID Tubing



T430/410 (-1 -2 -6005 -J1A)
Tee Reduction Connector with 400 Series Barbs, 1/8" (3.2 mm) and 1/16" (1.6 mm) ID Tubing



T430R410 (-1 -2 -6005 -J1A)
Tee Reduction Connector with 400 Series Barbs, 1/8" (3.2 mm) and 1/16" (1.6 mm) ID Tubing

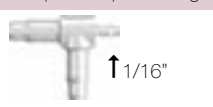

T230/220 (-1 -2 -6005 -9 -J1A)
Tee Reduction Connector with 200 Series Barbs, 1/8" (3.2 mm) and 3/32" (2.4 mm) ID Tubing

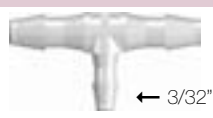

T230R220 (-1 -2 -6005 -9 -J1A)
Tee Reduction Connector with 200 Series Barbs, 1/8" (3.2 mm) and 3/32" (2.4 mm) ID Tubing



T430/420 (-1 -2 -3 -6005 -J1A)
Tee Reduction Connector with 400 Series Barbs, 1/8" (3.2 mm) and 3/32" (2.4 mm) ID Tubing

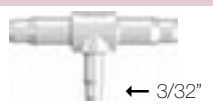

T430R420 (-1 -2 -6005 -J1A)
Tee Reduction Connector with 400 Series Barbs, 1/8" (3.2 mm) and 3/32" (2.4 mm) ID Tubing

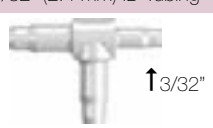

T360/220 (-1 -2 -6005 -9 -J1A)
Tee Reduction Connector with 200 and 300 Series Barbs, 1/4" (6.4 mm) and 3/32" (2.4 mm) ID Tubing

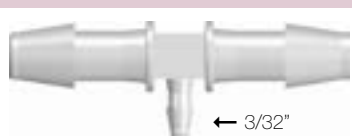

T360/230 (-1 -2 -6005 -9 -J1A)
Tee Reduction Connector with 200 and 300 Series Barbs, 1/4" (6.4 mm) and 1/8" (3.2 mm) ID Tubing

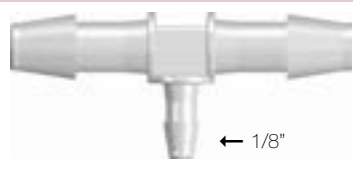

T360/250 (-1 -2 -6005 -9 -J1A)
Tee Reduction Connector with 200 and 300 Series Barbs, 1/4" (6.4 mm) and 3/16" (4.8 mm) ID Tubing

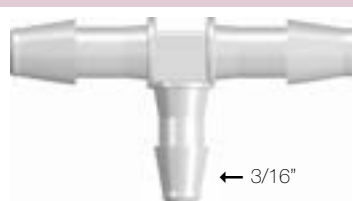

LARGE TUBE-TO-TUBE: Tee



Reference part shown: **T070/055**

Due to size we are not able to display all large Tube-To-Tube connectors. Please see www.nordsonmedical.com for part reference. Minimum package quantities vary by tube IDs, please verify minimum package sizes when placing orders.

T070/055 (-0 -6005 -9)
Tee Reduction Connector with 500 Series Barbs, 3/8" (9.5 mm) and 1/4" (6.4 mm) ID Tubing

T080/055 (-0 -6005 -9)
Tee Reduction Connector with 500 Series Barbs, 1/2" (12.7 mm) and 1/4" (6.4 mm) ID Tubing

T080/070 (-0 -6005 -9)
Tee Reduction Connector with 500 Series Barbs, 1/2" (12.7 mm) and 3/8" (9.5 mm) ID Tubing

T100/080 (-0 -6005 -9)
Tee Reduction Connector with 500 Series Barbs, 3/4" (19.0 mm) and 1/2" (12.7 mm) ID Tubing

T110/100 (-0 -6005)
Tee Reduction Connector with 500 Series Barbs, 1" (25.4 mm) and 3/4" (19.0 mm) ID Tubing

TUBE-TO-TUBE
FITTINGS

Y210 (-1 -2 -6005 -9 -J1A)

Y Connector with 200 Series Barbs, 1/16" (1.6 mm) ID Tubing



Y410 (-1 -2 -6005 -J1A)

Y Connector with 400 Series Barbs, 1/16" (1.6 mm) ID Tubing



Y220 (-1 -2 -6005 -6012 -9 -J1A)

Y Connector with 200 Series Barbs, 3/32" (2.4 mm) ID Tubing



Y420 (-1 -2 -6005 -J1A)

Y Connector with 400 Series Barbs, 3/32" (2.4 mm) ID Tubing



Y230 (-1 -2 -3 -6005 -6012 -9 -9002 -9010 -J1A)

Y Connector with 200 Series Barbs, 1/8" (3.2 mm) ID Tubing



Y430 (-1 -2 -6005 -J1A)

Y Connector with 400 Series Barbs, 1/8" (3.2 mm) ID Tubing



Y013 (-6005)

Y Connector with 500 Series Barbs, 1/8" (3.2 mm) ID Tubing



Y240 (-1 -2 -6005 -6012 -9 -J1A)

Y Connector with 200 Series Barbs, 5/32" (4.0 mm) ID Tubing



Y250 (-1 -2 -6005 -9 -9002 -J1A)

Y Connector with 200 Series Barbs, 3/16" (4.8 mm) ID Tubing



Y450 (-1 -2 -6005 -6012 -J1A)

Y Connector with 400 Series Barbs, 3/16" (4.8 mm) ID Tubing



Y260 (-1 -2 -6005 -9 -9002 -J1A)

Y Connector with 200 Series Barbs, 1/4" (6.4 mm) ID Tubing



Y460 (-1 -2 -6005 -9 -J1A)

Y Connector with 400 Series Barbs, 1/4" (6.4 mm) ID Tubing



TUBE-TO-TUBE:

Y

Y055 (-6005)

Y Connector with 500 Series Barbs, 1/4" (6.4 mm) ID Tubing



LARGE TUBE-TO-TUBE:

Y



Reference part shown: **Y070**

Due to size we are not able to display all large Tube-To-Tube connectors. Please see www.nordsonmedical.com for part reference. Minimum package quantities vary by tube IDs, please verify minimum package sizes when placing orders.

TUBE-TO-TUBE FITTINGS

Y070 (-0 -6005 -9)

Y Connector with 500 Series Barbs, 3/8" (9.5 mm) ID Tubing

Y670 (-6005 -9 -J1A)

Y Connector with 600 Series Barbs, 3/8" (9.5 mm) ID Tubing

Y080 (-0 -6005 -9)

Y Connector with 500 Series Barbs, 1/2" (12.7 mm) ID Tubing

Y680 (-6005 -9 -J1A)

Y Connector with 600 Series Barbs, 1/2" (12.7 mm) ID Tubing

Y090 (-0 -6005 -J1A)

Y Connector with 500 Series Barbs, 5/8" (16.0 mm) ID Tubing

Y690 (-6005)

Y Connector with 600 Series Barbs, 5/8" (16.0 mm) ID Tubing

Y100 (-0 -6005 -J1A)

Y Connector with 500 Series Barbs, 3/4" (19.0 mm) ID Tubing

Y6100 (-6005)

Y Connector with 600 Series Barbs, 3/4" (19.0 mm) ID Tubing

Y110 (-0 -6005)

Y Connector with 500 Series Barbs, 1" (25.4 mm) ID Tubing

Y6110 (-6005)

Y Connector with 600 Series Barbs, 1" (25.4 mm) ID Tubing

TUBE-TO-TUBE:

Multiport

3PF210 (-1 -6005)

Three-Port F Style Manifold with 200 Series Barbs for 1/16" (1.6 mm) ID Tubing



3PF220 (-1 -6005)

Three-Port F Style Manifold with 200 Series Barbs for 3/32" (2.4 mm) ID Tubing



3PF230 (-1 -6005)

Three-Port F Style Manifold with 200 Series Barbs for 1/8" (3.2 mm) ID Tubing



4PX210 (-1 -6005)

Four-Port Cross Style Manifold with 200 Series Barbs for 1/16" (1.6 mm) ID Tubing

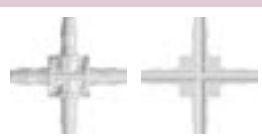

4PX220 (-1 -6005)

Four-Port Cross Style Manifold with 200 Series Barbs for 3/32" (2.4 mm) ID Tubing

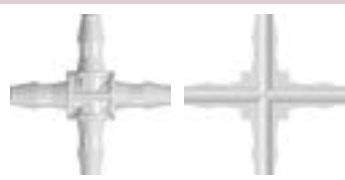

4PX230 (-1 -6005)

Four-Port Cross Style Manifold with 200 Series Barbs for 1/8" (3.2 mm) ID Tubing

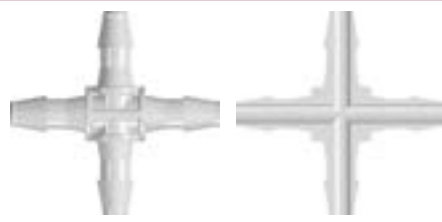

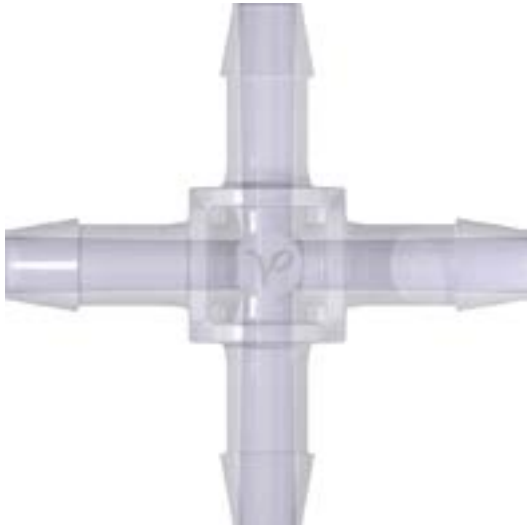

Reference part shown: 4PX670

Due to size we are not able to display all large Tube-To-Tube connectors. Please see www.nordsonmedical.com for part reference. Minimum package quantities vary by tube IDs, please verify minimum package sizes when placing orders.

4PX655 (-6005)

Four-Port Cross Style Manifold with 600 Series Barbs for 1/4" (6.4 mm) ID Tubing

4PX670 (-6005)

Four-Port Cross Style Manifold with 600 Series Barbs for 3/8" (9.5 mm) ID Tubing

4PX680 (-6005)

Four-Port Cross Style Manifold with 600 Series Barbs for 1/2" (12.7 mm) ID Tubing

TUBE-TO-TUBE:
Multiport

4PDL210 (-1 -6005)

Four-Port Double Elbow Style Manifold with 200 Series Barbs, 1/16" (1.6 mm) ID Tubing



4PDL220 (-1 -6005)

Four-Port Double Elbow Style Manifold with 200 Series Barbs, 3/32" (2.4 mm) ID Tubing



4PDL230 (-1 -6005)

Four-Port Double Elbow Style Manifold with 200 Series Barbs, 1/8" (3.2 mm) ID Tubing



4PLL210 (-1 -6005)

Four-Port Thru Flow Double Elbow Style Manifold with 200 Series Barbs, 1/16" (1.6 mm) ID Tubing



4PLL220 (-1 -6005 -9)

Four-Port Thru Flow Double Elbow Style Manifold with 200 Series Barbs, 3/32" (2.4 mm) ID Tubing



4PLL230 (-1 -2 -6005)

Four-Port Thru Flow Double Elbow Style Manifold with 200 Series Barbs, 1/8" (3.2 mm) ID Tubing



6PDT210 (-1 -6005)

Six-Port Double T Style Manifold with 200 Series Barbs for 1/16" (1.6 mm) ID Tubing

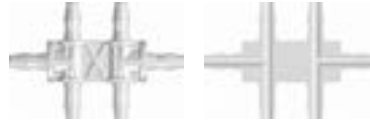

6PDT220 (-1 -6005)

Six-Port Double T Style Manifold with 200 Series Barbs for 3/32" (2.4 mm) ID Tubing

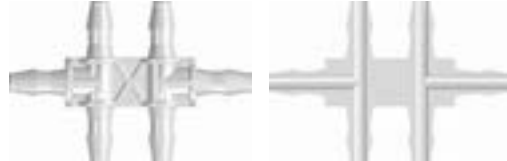

6PDT230 (-1 -6005)

Six-Port Double T Style Manifold with 200 Series Barbs for 1/8" (3.2 mm) ID Tubing

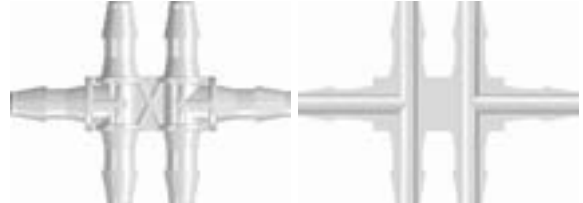

6PTT210 (-1 -6005)

Six-Port Thru Flow Double T Style Manifold with 200 Series Barbs for 1/16" (1.6 mm) ID Tubing



6PTT220 (-1 -6005)

Six-Port Thru Flow Double T Style Manifold with 200 Series Barbs for 3/32" (2.4 mm) ID Tubing

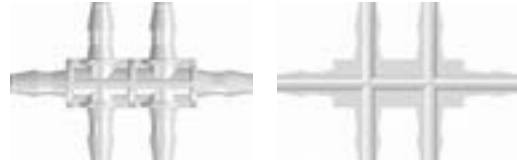

6PTT230 (-1 -6005)

Six-Port Thru Flow Double T Style Manifold with 200 Series Barbs for 1/8" (3.2 mm) ID Tubing



TUBE-TO-TUBE: Press-In Plugs

PIP10 (-1 -2 -6005 -J1A)
Press-In Plug with Classic Series Barb, 1/16" (1.6 mm) ID Tubing



PIP210 (-1 -2 -6005 -J1A)
Press-In Plug with 200 Series Barb, 1/16" (1.6 mm) ID Tubing



PIP20 (-1 -2 -6005 -J1A)
Press-In Plug with Classic Series Barb, 3/32" (2.4 mm) ID Tubing



PIP220 (-1 -2 -6005 -6012 -J1A)
Press-In Plug with 200 Series Barb, 3/32" (2.4 mm) ID Tubing



PIP30 (-1 -2 -6005 -J1A)
Press-In Plug with Classic Series Barb, 1/8" (3.2 mm) ID Tubing



PIP230 (-1 -2 -6005 -6012 -J1A)
Press-In Plug with 200 Series Barb, 1/8" (3.2 mm) ID Tubing



PIP40 (-1 -2 -6005 -J1A)
Press-In Plug with Classic Series Barb, 5/32" (4.0 mm) ID Tubing



PIP240 (-1 -2 -6005 -J1A)
Press-In Plug with 200 Series Barb, 5/32" (4.0 mm) ID Tubing



PIP50 (-1 -2 -6005 -J1A)
Press-In Plug with Classic Series Barb, 3/16" (4.8 mm) ID Tubing



PIP60 (-1 -2 -6005 -J1A)
Press-In Plug with Classic Series Barb, 1/4" (6.4 mm) ID Tubing

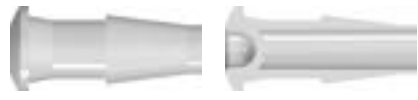

LARGE TUBE-TO-TUBE: Press-In Plugs

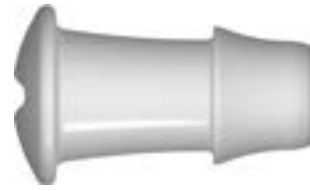

Reference part shown: **PIP090**

Due to size we are not able to display all large Tube-To-Tube connectors. Please see www.nordsonmedical.com for part reference. Minimum package quantities vary by tube IDs, please verify minimum package sizes when placing orders.

PIP070 (-0 -6005)
Press-In Plug with 500 Series Barb, 3/8" (9.5 mm) ID Tubing

PIP670 (-6005)
Press-In Plug with 600 Series Barb, 3/8" (9.5 mm) ID Tubing

PIP080 (-6005)
Press-In Plug with 500 Series Barb, 1/2" (12.7 mm) ID tubing

PIP680 (-6005)
Press-In Plug with 600 Series Barb, 1/2" (12.7 mm) ID Tubing

PIP090 (-6005)
Press-In Plug with 500 Series Barb, 5/8" (16.0 mm) ID Tubing

PIP6100 (-6005)
Press-In Plug with 600 Series Barb, 3/4" (19.0 mm) ID Tubing

PIP6110 (-6005)
Press-In Plug with 600 Series Barb, 1" (25.4 mm) ID Tubing

TUBE-TO-TUBE
FITTINGS

TUBE-TO-TUBE:

Ultrasonically Weldable Barb

U10 (-1 -2 -7 -9)

Ultrasonically Weldable Fitting to Classic Series Barb, 1/16" (1.6 mm) ID Tubing



U20 (-1 -2 -7)

Ultrasonically Weldable Fitting to Classic Series Barb, 3/32" (2.4 mm) ID Tubing



U30 (-1 -2 -7)

Ultrasonically Weldable Fitting to Classic Series Barb, 1/8" (3.2 mm) ID Tubing



TUBE-TO-TUBE PANEL MOUNTS: Straight Through and Reducer

PMK210 (-1 -6005)

Panel Mount Connector 10-32 UNF to 200 Series Barbs, 1/16" (1.6 mm) ID Tubing



PMK220 (-1 -6005)

Panel Mount Connector 10-32 UNF to 200 Series Barbs, 3/32" (2.4 mm) ID Tubing



PMS230 (-1 -6005)

Panel Mount Connector 1/4-28 UNF to 200 Series Barbs, 1/8" (3.2 mm) ID Tubing



PMK220-210 (-1 -6005)

Panel Mount Reduction Connector 10-32 UNF to 200 Series Barbs, 3/32" (2.4 mm) and 1/16" (1.6 mm) ID Tubing



PMS230-210 (-1 -6005 -J1A)

Panel Mount Reduction Connector 1/4-28 UNF to 200 Series Barbs, 1/8" (3.2 mm) and 1/16" (1.6 mm) ID Tubing



PMS230-220 (-1 -6005)

Panel Mount Reduction Connector 1/4-28 UNF to 200 Series Barbs, 1/8" (3.2 mm) and 3/32" (2.4 mm) ID Tubing



TUBE-TO-TUBE PANEL MOUNT ACCESSORIES: Lock Nuts and Color Coding Rings

CCR (-1 -2 -3 -4 -5 -06 -07)

Color Coded Ring (For use with PMS, PMK, FTLLB or FTLB panel mount fittings)



CCLR (-1 -2 -3 -4 -5 -06 -07)

Color Coded Lock Ring (For use with PMS, PMK, FTLLB or FTLB panel mount fittings)



PMKN (-XO)

Panel Mount Nut 10-32 UNF with 3/8" Hex (For use with PMK panel mount fittings)



PMSN (-XO)

Panel Mount Nut 1/4-28 UNF with 7/16" Hex (For use with PMS, FTLB, and FTLLB panel mount fittings)



LNS (-1 -2 -3 -4 -5 -06 -6005 -07 -81 -J1A)

1/4-28 UNF Panel Mount Lock Nut (For use with PMS, FTLLB or FTLB panel mount fittings)



Select the Correct Lock Nut for Your Panel Mount:

PART	Dimension A	Use Lock Nut
PMK Series	.193"	PMKN
PMS Series	.255"	PMSN or LNS

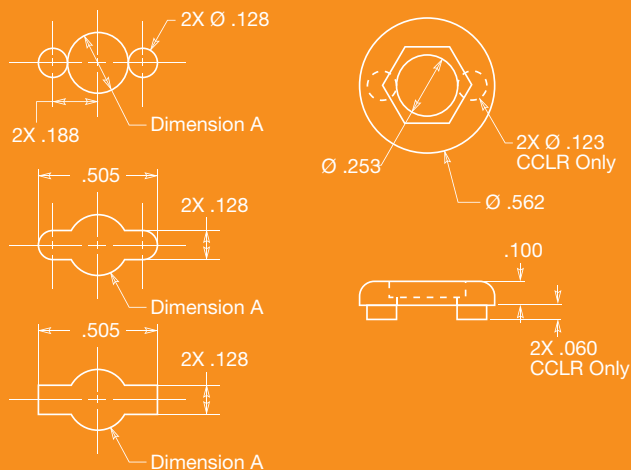

TUBE-TO-TUBE
FITTINGS

THREADED

Fittings



10-32 UNF Special Tapered Thread **PG-89** 1/4-28 UNF **PG-92**



1/4-28 UNF Bottom Sealing **PG-93** Metric - M6x1 **PG-94**



Metric - M5x.8 **PG-94** 1/16-27 NPT **PG-95**



1/8-27 NPT **PG-96** 1/4-18 NPT Reducers **PG-97**



The X Thread

Nordson MEDICAL X Series components have a tapered 10-32 thread that functions like a pipe thread. In comparison to standard 10-32 UNF threaded fittings, the tapered design works better with oversized ports and ports which are not perpendicular to the face of the component.

The 120 degree chamfer under the hex provides a seal when the fitting is tightened into a port with a countersink as shown below. It also seals on the thread due to interference on the pitch diameter. When using an elbow or tee, the tapered thread tightens radially and facilitates directional alignment of the barb.

Other Thread Series

K, B, C and D Series fittings, designed for use with 10-32 UNF ports, are straight-threaded components. These fittings seal against the 120 degree chamfer under the hex on the fitting and do not tighten radially as they are assembled. S Series fittings are straight threaded components for 1/4-28 UNF ports, M5 Series are for M5 x .8 ports and M6 Series are for M6 x 1 ports.

Part numbers for fittings with pipe threads are noted below. Those for use with 1/16-27 NPT ports have part numbers prefixed with 16; those for 1/8-27 NPT ports have part numbers prefixed with 18; and those for 1/4-18 NPT ports have part numbers prefixed with 14.

The features shown below must be incorporated into the port when using our B, C, D, X, K, S, M5 and M6 Series fittings. Failure to do so will jeopardize the performance of the seal between the fitting and port. For applications in which this seal is highly critical, we recommend that you contact a sealant specialist.

When working with threaded parts, Nordson MEDICAL strongly recommends that you test sample parts in your application.

Nordson MEDICAL's Thread Series	Dimension A Thread Length	Clearance Needed to Achieve Chamfer Seal	Dimension B Countersink Diameter	Feature C Internal Screw Thread Series
X	.200"	.250"	.210"-.230"	10-32 UNF 2B
K, B, C, D	.156"	.200"	.210"-.230"	10-32 UNF 2B
S	.204"	.250"	.270"-.290"	1/4-28 UNF 2B
M5	.192"	.250"	.210"-.230"	M5 X .8
M6	.235"	.375"	.270"-.290"	M6 X 1

THREAD:**10-32 UNF, Special Tapered Thread****K10 (-1 -2 -6005 -J1A)**

10-32 UNF Thread with 1/4" Hex to Classic Series Barb, 1/16" (1.6 mm) ID Tubing

**X10 (-1 -2 -6005 -J1A)**

10-32 Special Tapered Thread with 1/4" Hex to Classic Series Barb, 1/16" (1.6 mm) ID Tubing

**K210 (-1 -2 -3 -5 -6005 -J1A)**

10-32 UNF Thread with 1/4" Hex to 200 Series Barb, 1/16" (1.6 mm) ID Tubing

**X210 (-1 -2 -3 -5 -6005 -6012 -J1A)**

10-32 Special Tapered Thread with 1/4" Hex to 200 Series Barb, 1/16" (1.6 mm) ID Tubing

**K410 (-1 -2 -6005 -J1A)**

10-32 UNF Thread with 1/4" Hex to 400 Series Barb, 1/16" (1.6 mm) ID Tubing

**X410 (-1 -2 -6005 -J1A)**

10-32 Special Tapered Thread with 1/4" Hex to 400 Series Barb, 1/16" (1.6 mm) ID Tubing

**D (-1 -2 -3 -4 -5 -6005 -J1A)**

10-32 UNF Thread with 1/4" Hex to Classic Series Barb, 3/32" (2.4 mm) ID Tubing

**K220 (-1 -2 -6005 -6012 -J1A)**

10-32 UNF Thread with 1/4" Hex to 200 Series Barb, 3/32" (2.4 mm) ID Tubing

**X220 (-1 -2 -3 -6005 -J1A)**

10-32 Special Tapered Thread with 1/4" Hex to 200 Series Barb, 3/32" (2.4 mm) ID Tubing

**K420 (-1 -2 -6005 -J1A)**

10-32 UNF Thread with 1/4" Hex to 400 Series Barb, 3/32" (2.4 mm) ID Tubing

**X420 (-1 -2 -6005 -J1A)**

10-32 Special Tapered Thread with 1/4" Hex to 400 Series Barb, 3/32" (2.4 mm) ID Tubing

**B (-1 -2 -3 -4 -5 -6005 -J1A)**

10-32 UNF Thread with 1/4" Hex to Classic Series Barb, 1/8" (3.2 mm) ID Tubing

**C (-1 -2 -3 -4 -5 -6005 -J1A)**

10-32 UNF Thread with 1/4" Hex to Classic Series Barb, Short Neck, 1/8" (3.2 mm) ID Tubing

**K230 (-1 -2 -6005 -J1A)**

10-32 UNF Thread with 1/4" Hex to 200 Series Barb, 1/8" (3.2 mm) ID Tubing

**X230 (-1 -2 -3 -5 -6005 -6012 -J1A)**

10-32 Special Tapered Thread with 1/4" Hex to 200 Series Barb, 1/8" (3.2 mm) ID Tubing

**K430 (-1 -2 -6005 -J1A)**

10-32 UNF Thread with 1/4" Hex to 400 Series Barb, 1/8" (3.2 mm) ID Tubing

**X430 (-1 -2 -3 -6005 -J1A)**

10-32 Special Tapered Thread with 1/4" Hex to 400 Series Barb, 1/8" (3.2 mm) ID Tubing

**K240 (-1 -2 -6005 -J1A)**

10-32 UNF Thread with 1/4" Hex to 200 Series Barb, 5/32" (4.0 mm) ID Tubing

**X240 (-1 -2 -6005 -J1A)**

10-32 Special Tapered Thread with 1/4" Hex to 200 Series Barb, 5/32" (4.0 mm) ID Tubing

**K445 (-1 -2 -6005 -J1A)**

10-32 UNF Thread with 1/4" Hex to 400 Series Barb, .170" (4.3 mm) ID Tubing

**X445 (-1 -2 -6005 -J1A)**

10-32 Special Tapered Thread with 1/4" Hex to 400 Series Barb, .170" (4.3 mm) ID Tubing



THREAD:

10-32 UNF, Special Tapered Thread Elbow

KL210 (-1 -2 -6005 -J1A)

10-32 UNF Thread Elbow with 1/4" Hex to 200 Series Barb, 1/16" (1.6 mm) ID Tubing



XL420 (-1 -2 -6005 -J1A)

10-32 Special Tapered Thread Elbow with 1/4" Hex to 400 Series Barb, 3/32" (2.4 mm) ID Tubing



XL210 (-1 -2 -6005 -6012 -J1A)

10-32 Special Tapered Thread Elbow with 1/4" Hex to 200 Series Barb, 1/16" (1.6 mm) ID Tubing



KL230 (-1 -2 -6005 -J1A)

10-32 UNF Thread Elbow with 1/4" Hex to 200 Series Barb, 1/8" (3.2 mm) ID Tubing



KL410 (-1 -2 -6005 -J1A)

10-32 UNF Thread Elbow with 1/4" Hex to 400 Series Barb, 1/16" (1.6 mm) ID Tubing



XL230 (-1 -2 -6005 -6012 -J1A)

10-32 Special Tapered Thread Elbow with 1/4" Hex to 200 Series Barb, 1/8" (3.2 mm) ID Tubing



XL410 (-1 -2 -6005 -J1A)

10-32 Special Tapered Thread Elbow with 1/4" Hex to 400 Series Barb, 1/16" (1.6 mm) ID Tubing



KL430 (-1 -2 -6005 -J1A)

10-32 UNF Thread Elbow with 1/4" Hex to 400 Series Barb, 1/8" (3.2 mm) ID Tubing



KL220 (-1 -2 -6005 -J1A)

10-32 UNF Thread Elbow with 1/4" Hex to 200 Series Barb, 3/32" (2.4 mm) ID Tubing



XL430 (-1 -2 -6005 -J1A)

10-32 Special Tapered Thread Elbow with 1/4" Hex to 400 Series Barb, 1/8" (3.2 mm) ID Tubing



XL220 (-1 -2 -6005 -6012 -J1A)

10-32 Special Tapered Thread Elbow with 1/4" Hex to 200 Series Barb, 3/32" (2.4 mm) ID Tubing



KL420 (-1 -2 -6005 -J1A)

10-32 UNF Thread Elbow with 1/4" Hex to 400 Series Barb, 3/32" (2.4 mm) ID Tubing



THREADED FITTINGS

Technical Assistance

Trying to choose the correct part? Need more material information than is published in this catalog? Call Nordson MEDICAL Technical Support **(970) 267-5200**.

THREAD:**10-32 UNF, Special Tapered Thread Tee****KT210 (-1 -2 -6005 -J1A)**

10-32 UNF Thread Tee with 1/4" Hex to 200 Series Barb,
1/16" (1.6 mm) ID Tubing

**KT420 (-1 -2 -6005 -J1A)**

10-32 UNF Thread Tee with 1/4" Hex to 400 Series Barb,
3/32" (2.4 mm) ID Tubing

**XT210 (-1 -2 -6005 -J1A)**

10-32 Special Tapered Thread Tee with 1/4" Hex to 200 Series Barb,
1/16" (1.6 mm) ID Tubing

**XT420 (-1 -2 -6005 -J1A)**

10-32 Special Tapered Thread Tee with 1/4" Hex to 400 Series Barb,
3/32" (2.4 mm) ID Tubing

**KT410 (-1 -2 -6005 -J1A)**

10-32 UNF Thread Tee with 1/4" Hex to 400 Series Barb,
1/16" (1.6 mm) ID Tubing

**KT230 (-1 -2 -6005 -J1A)**

10-32 UNF Thread Tee with 1/4" Hex to 200 Series Barb,
1/8" (3.2 mm) ID Tubing

**XT410 (-1 -2 -6005 -J1A)**

10-32 Special Tapered Thread Tee with 1/4" Hex to 400 Series Barb,
1/16" (1.6 mm) ID Tubing

**XT230 (-1 -2 -6005 -J1A)**

10-32 Special Tapered Thread Tee with 1/4" Hex to 200 Series Barb,
1/8" (3.2 mm) ID Tubing

**KT220 (-1 -2 -6005 -J1A)**

10-32 UNF Thread Tee with 1/4" Hex to 200 Series Barb,
3/32" (2.4 mm) ID Tubing

**KT430 (-1 -2 -6005 -J1A)**

10-32 UNF Thread Tee with 1/4" Hex to 400 Series Barb,
1/8" (3.2 mm) ID Tubing

**XT220 (-1 -2 -6005 -J1A)**

10-32 Special Tapered Thread Tee with 1/4" Hex to 200 Series Barb,
3/32" (2.4 mm) ID Tubing

**XT430 (-1 -2 -6005 -J1A)**

10-32 Special Tapered Thread Tee with 1/4" Hex to 400 Series Barb,
1/8" (3.2 mm) ID Tubing

**Part Drawings Online!**

Nordson MEDICAL provides dimensional drawings available for download for all of its fittings.

www.nordsonmedical.com

THREAD:

10-32 UNF, Special Tapered Thread Couplers and Plugs

KN (-1 -2 -6005 -J1A)

10-32 UNF Thread Coupler with 1/4" Hex

**XN (-1 -2 -6005 -J1A)**

10-32 Special Tapered Thread Coupler with 1/4" Hex

**KP (-1 -2 -6005 -6012 -J1A)**

10-32 UNF Thread Plug with 1/4" Hex

**XP (-1 -2 -6005 -J1A)**

10-32 Special Tapered Thread Plug with 1/4" Hex

**THREAD:**

1/4-28 UNF

S10 (-1 -2 -6005 -J1A)

1/4-28 UNF Thread with 5/16" Hex to Classic Series Barb, 1/16" (1.6 mm) ID Tubing

**S210 (-1 -2 -6005 -J1A)**

1/4-28 UNF Thread with 5/16" Hex to 200 Series Barb, 1/16" (1.6 mm) ID Tubing

**S410 (-1 -2 -6005 -J1A)**

1/4-28 UNF Thread with 5/16" Hex to 400 Series Barb, 1/16" (1.6 mm) ID Tubing

**S20 (-1 -2 -6005 -J1A)**

1/4-28 UNF Thread with 5/16" Hex to Classic Series Barb, 3/32" (2.4 mm) ID Tubing

**S220 (-1 -2 -6005 -J1A)**

1/4-28 UNF Thread with 5/16" Hex to 200 Series Barb, 3/32" (2.4 mm) ID Tubing

**S420 (-1 -2 -6005 -J1A)**

1/4-28 UNF Thread with 5/16" Hex to 400 Series Barb, 3/32" (2.4 mm) ID Tubing

**S30 (-1 -2 -6005 -J1A)**

1/4-28 UNF Thread with 5/16" Hex to Classic Series Barb, 1/8" (3.2 mm) ID Tubing

**S230 (-1 -2 -6005 -6012 -J1A)**

1/4-28 UNF Thread with 5/16" Hex to 200 Series Barb, 1/8" (3.2 mm) ID Tubing

**Looking for Something Different?**

Most of our best product ideas have come from you, our customers. While we pride ourselves on our extensive product offering, we recognize that your needs are ever-changing and that our products, too, must adapt to your needs.

If there's a new product you think Nordson MEDICAL should make, please send us an Email at designcenter@nordsonmedical.com describing your product concept in as much detail as you desire. We will contact you with any questions, and who knows - the next catalog edition could include products YOU told us to build.

See page 14 for more information on the Design Center!



THREAD:
1/4-28 UNF

S430 (-1 -2 -6005 -J1A)

1/4-28 UNF Thread with 5/16" Hex to 400 Series Barb,
1/8" (3.2 mm) ID Tubing



S40 (-1 -2 -6005 -J1A)

1/4-28 UNF Thread with 5/16" Hex to Classic Series Barb,
5/32" (4.0 mm) ID Tubing



S240 (-1 -2 -6005 -J1A)

1/4-28 UNF Thread with 5/16" Hex to 200 Series Barb,
5/32" (4.0 mm) ID Tubing



S445 (-1 -2 -6005 -J1A)

1/4-28 UNF Thread with 5/16" Hex to 400 Series Barb,
.170" (4.3 mm) ID Tubing



S50 (-1 -2 -6005 -J1A)

1/4-28 UNF Thread with 5/16" Hex to Classic Series Barb,
3/16" (4.8 mm) ID Tubing



S250 (-1 -2 -6005 -J1A)

1/4-28 UNF Thread with 5/16" Hex to 200 Series Barb,
3/16" (4.8 mm) ID Tubing



S450 (-1 -2 -6005 -J1A)

1/4-28 UNF Thread with 5/16" Hex to 400 Series Barb,
3/16" (4.8 mm) ID Tubing



SP (-1 -2 -6005 -J1A)

1/4-28 UNF Thread Plug with 5/16" Hex



THREAD:
1/4-28 UNF Bottom Sealing

ABR004-6005 UNDER (-1 -2 -3 -4 -5)

1/4-28 UNF Bottom Sealing Rotating Thread with 5/16" Hex to
500 Series Barb, 1/16" (1.6 mm) ID Tubing



Recommended torque:
Polypropylene - 1.5-2 in. lbs.
Kynar® - 2-4 in. lbs.

ABR004-J1A UNDER (-1 -2 -3 -4 -5 -J1A)

1/4-28 UNF Bottom Sealing Rotating Thread with 5/16" Hex to
500 Series Barb, 1/16" (1.6 mm) ID Tubing



Recommended torque:
Polypropylene - 1.5-2 in. lbs.
Kynar® - 2-4 in. lbs.

ABR007-6005 UNDER (-1 -2 -3 -4 -5)

1/4-28 UNF Bottom Sealing Rotating Thread with 5/16" Hex to
500 Series Barb, 3/32" (2.4 mm) ID Tubing



Recommended torque:
Polypropylene - 1.5-2 in. lbs.
Kynar® - 2-4 in. lbs.

ABR007-J1A UNDER (-1 -2 -3 -4 -5 -J1A)

1/4-28 UNF Bottom Sealing Rotating Thread with 5/16" Hex to
500 Series Barb, 3/32" (2.4 mm) ID Tubing



Recommended torque:
Polypropylene - 1.5-2 in. lbs.
Kynar® - 2-4 in. lbs.

ABR013-6005 UNDER (-1 -2 -3 -4 -5 -6012)

1/4-28 UNF Bottom Sealing Rotating Thread with 5/16" Hex to
500 Series Barb, 1/8" (3.2 mm) ID Tubing



Recommended torque:
Polypropylene - 1.5-2 in. lbs.
Kynar® - 2-4 in. lbs.

ABR013-J1A UNDER (-1 -2 -3 -4 -5 -J1A)

1/4-28 UNF Bottom Sealing Rotating Thread with 5/16" Hex to
500 Series Barb, 1/8" (3.2 mm) ID Tubing



Recommended torque:
Polypropylene - 1.5-2 in. lbs.
Kynar® - 2-4 in. lbs.

TECS116 (-6005 -J1A)

1/4-28 UNF Bottom Sealing Thread Tube End Coupler with 5/16" Hex,
1/16" (1.6 mm) OD Tubing



TECS118 (-6005 -J1A)

1/4-28 UNF Bottom Sealing Thread Tube End Coupler with 5/16" Hex,
1/8" (3.2 mm) OD Tubing



THREAD:
M6x1

M6210 (-1 -2 -6005)

M6x1 Thread with 5/16" Hex to 200 Series Barb, 1/16" (1.6 mm) ID Tubing



M6410 (-1 -2 -6005 -J1A)

M6x1 Thread with 5/16" Hex to 400 Series Barb, 1/16" (1.6 mm) ID Tubing



M6220 (-1 -2 -6005 -J1A)

M6x1 Thread with 5/16" Hex to 200 Series Barb, 3/32" (2.4 mm) ID Tubing



M6420 (-1 -2 -6005 -J1A)

M6x1 Thread with 5/16" Hex to 400 Series Barb, 3/32" (2.4 mm) ID Tubing



M6230 (-1 -2 -6005 -J1A)

M6x1 Thread with 5/16" Hex to 200 Series Barb, 1/8" (3.2 mm) ID Tubing



M6430 (-1 -2 -6005 -J1A)

M6x1 Thread with 5/16" Hex to 400 Series Barb, 1/8" (3.2 mm) ID Tubing



M6240 (-1 -2 -6005 -J1A)

M6x1 Thread with 5/16" Hex to 200 Series Barb, 5/32" (4.0 mm) ID Tubing



M6445 (-1 -2 -6005 -J1A)

M6x1 Thread with 5/16" Hex to 400 Series Barb, .170" (4.3 mm) ID Tubing



THREAD:
M6x1

M6250 (-1 -2 -6005 -J1A)

M6x1 Thread with 5/16" Hex to 200 Series Barb, 3/16" (4.8 mm) ID Tubing



M6450 (-1 -2 -6005 -J1A)

M6x1 Thread with 5/16" Hex to 400 Series Barb, 3/16" (4.8 mm) ID Tubing



M6P (-1 -2 -6005 -J1A)

M6x1 Thread Plug with 5/16" Hex



THREAD:
M5x.8

M5210 (-1 -2 -6005)

M5x.8 Thread with 1/4" Hex to 200 Series Barb, 1/16" (1.6 mm) ID Tubing



M5220 (-1 -2 -6005)

M5x.8 Thread with 1/4" Hex to 200 Series Barb, 3/32" (2.4 mm) ID Tubing



M5230 (-1 -2 -6005)

M5x.8 Thread with 1/4" Hex to 200 Series Barb, 1/8" (3.2 mm) ID Tubing



M5240 (-1 -2 -6005)

M5x.8 Thread with 1/4" Hex to 200 Series Barb, 5/32" (4.0 mm) ID Tubing



THREADED FITTINGS

Part Drawings Online!

Nordson MEDICAL provides dimensional drawings available for download for all of its fittings.
www.nordsonmedical.com

Technical Assistance

Trying to choose the correct part? Need more material information than is published in this catalog? Call Nordson MEDICAL Technical Support (970) 267-5200.

1610 (-1 -2 -6005 -J1A)

1/16-27 NPT Thread with 5/16" Hex to Classic Series Barb,
1/16" (1.6 mm) ID Tubing



16430 (-1 -2 -6005 -J1A)

1/16-27 NPT Thread with 5/16" Hex to 400 Series Barb,
1/8" (3.2 mm) ID Tubing



16210 (-1 -2 -6005 -J1A)

1/16-27 NPT Thread with 5/16" Hex to 200 Series Barb,
1/16" (1.6 mm) ID Tubing



1640 (-1 -2 -6005 -J1A)

1/16-27 NPT Thread with 5/16" Hex to Classic Series Barb,
5/32" (4.0 mm) ID Tubing



16410 (-1 -2 -6005 -J1A)

1/16-27 NPT Thread with 5/16" Hex to 400 Series Barb,
1/16" (1.6 mm) ID Tubing



16240 (-1 -2 -6005 -J1A)

1/16-27 NPT Thread with 5/16" Hex to 200 Series Barb,
5/32" (4.0 mm) ID Tubing



1620 (-1 -2 -6005 -J1A)

1/16-27 NPT Thread with 5/16" Hex to Classic Series Barb,
3/32" (2.4 mm) ID Tubing



16445 (-1 -2 -6005 -J1A)

1/16-27 NPT Thread with 5/16" Hex to 400 Series Barb,
.170" (4.3 mm) ID Tubing



16220 (-1 -2 -6005 -J1A)

1/16-27 NPT Thread with 5/16" Hex to 200 Series Barb,
3/32" (2.4 mm) ID Tubing



1650 (-1 -2 -6005 -J1A)

1/16-27 NPT Thread with 5/16" Hex to Classic Series Barb,
3/16" (4.8 mm) ID Tubing



16420 (-1 -2 -6005 -J1A)

1/16-27 NPT Thread with 5/16" Hex to 400 Series Barb,
3/32" (2.4 mm) ID Tubing



16250 (-1 -2 -6005 -J1A)

1/16-27 NPT Thread with 5/16" Hex to 200 Series Barb,
3/16" (4.8 mm) ID Tubing



1630 (-1 -2 -6005 -J1A)

1/16-27 NPT Thread with 5/16" Hex to Classic Series Barb,
1/8" (3.2 mm) ID Tubing



16450 (-1 -2 -6005 -J1A)

1/16-27 NPT Thread with 5/16" Hex to 400 Series Barb,
3/16" (4.8 mm) ID Tubing



16230 (-1 -2 -6005 -J1A)

1/16-27 NPT Thread with 5/16" Hex to 200 Series Barb,
1/8" (3.2 mm) ID Tubing



1600 (-1 -2 -6005 -J1A)

1/16-27 NPT Thread Plug with 5/16" Hex



THREAD:
1/8-27 NPT

1810 (-1 -2 -6005 -J1A)
1/8-27 NPT Thread with 7/16" Hex to Classic Series Barb,
1/16" (1.6 mm) ID Tubing



18230 (-1 -2 -6005 -J1A)
1/8-27 NPT Thread with 7/16" Hex to 200 Series Barb,
1/8" (3.2 mm) ID Tubing



18210 (-1 -2 -6005 -J1A)
1/8-27 NPT Thread with 7/16" Hex to 200 Series Barb,
1/16" (1.6 mm) ID Tubing



18430 (-1 -2 -6005 -J1A)
1/8-27 NPT Thread with 7/16" Hex to 400 Series Barb,
1/8" (3.2 mm) ID Tubing

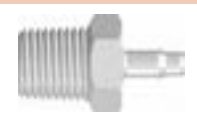

18410 (-1 -2 -6005 -J1A)
1/8-27 NPT Thread with 7/16" Hex to 400 Series Barb,
1/16" (1.6 mm) ID Tubing



1840 (-1 -2 -6005 -J1A)
1/8-27 NPT Thread with 7/16" Hex to Classic Series Barb,
5/32" (4.0 mm) ID Tubing



1820 (-1 -2 -6005 -J1A)
1/8-27 NPT Thread with 7/16" Hex to Classic Series Barb,
3/32" (2.4 mm) ID Tubing



18240 (-1 -2 -6005 -J1A)
1/8-27 NPT Thread with 7/16" Hex to 200 Series Barb,
5/32" (4.0 mm) ID Tubing



18220 (-1 -2 -6005 -J1A)
1/8-27 NPT Thread with 7/16" Hex to 200 Series Barb,
3/32" (2.4 mm) ID Tubing



18445 (-1 -2 -6005 -J1A)
1/8-27 NPT Thread with 7/16" Hex to 400 Series Barb,
.170" (4.3 mm) ID Tubing



THREADED
FITTINGS

18420 (-1 -2 -6005 -J1A)
1/8-27 NPT Thread with 7/16" Hex to 400 Series Barb,
3/32" (2.4 mm) ID Tubing



1850 (-1 -2 -6005 -J1A)
1/8-27 NPT Thread with 7/16" Hex to Classic Series Barb,
3/16" (4.8 mm) ID Tubing



1830 (-1 -2 -6005 -J1A)
1/8-27 NPT Thread with 7/16" Hex to Classic Series Barb,
1/8" (3.2 mm) ID Tubing



1860 (-1 -2 -6005 -6012 -J1A)
1/8-27 NPT Thread with 7/16" Hex to Classic Series Barb,
1/4" (6.4 mm) ID Tubing



THREAD:
1/8-27 NPT Elbows

18L230 (-1 -2 -6005 -6012 -J1A)
1/8-27 NPT Thread Elbow with 7/16" Hex to 200 Series Barb,
1/8" (3.2 mm) ID Tubing



18L250 (-1 -2 -6005 -J1A)
1/8-27 NPT Thread Elbow with 7/16" Hex to 200 Series Barb,
3/16" (4.8 mm) ID Tubing



18L260 (-1 -2 -6005 -J1A)
1/8-27 NPT Thread Elbow with 7/16" Hex to 200 Series Barb,
1/4" (6.4 mm) ID Tubing



THREAD:
1/8-27 NPT Tees

18T250 (-1 -2 -6005 -J1A)
1/8-27 NPT Thread Tee with 7/16" Hex to 200 Series Barb,
3/16" (4.8 mm) ID Tubing



18T260 (-1 -2 -6005 -J1A)
1/8-27 NPT Thread Tee with 7/16" Hex to 200 Series Barb,
1/4" (6.4 mm) ID Tubing



THREAD:
1/8-27 NPT Plugs

1800 (-1 -2 -6005 -J1A)
1/8-27 NPT Thread Plug with 7/16" Hex

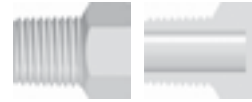

THREAD:
1/8-27 NPT Reducers

1801 (-1 -2 -6005 -J1A)
Reducer with 1/8-27 NPT Male Thread and 7/16" Hex to
10-32 UNF Female Thread



1802 (-1 -2 -6005 -J1A)
Reducer with 1/8-27 NPT Male Thread and 7/16" Hex to
1/4-28 UNF Female Thread

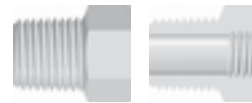

THREAD:
1/4-18 NPT Reducers

1401 (-1 -2 -6005 -J1A)
Reducer with 1/4-18 NPT Male Thread and 9/16" Hex to
10-32 UNF Female Thread

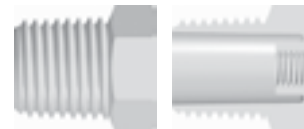

1402 (-1 -2 -6005 -J1A)
Reducer with 1/4-18 NPT Male Thread and 9/16" Hex to
1/4-28 UNF Female Thread

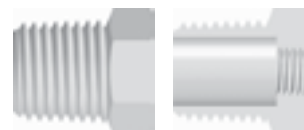

THREADED
FITTINGS

Need Samples for Evaluation?

You can call to request most of our standard product in quantities of 5, or less, for free application evaluation.
+1 (970) 267-5200 Toll Free: (888) 404-5837

BUILD-A-PART®

Fittings



Junction Blocks

PG-99



Accessories

PG-100



Barbs

PG-100



Threads

PG-101



Bonding Suggestions

Prior to actually bonding, press together a model of the manifold to use as a reference.

Do not mix plastic resins. Consult your adhesive specialist if you need to bond dissimilar materials.

These components are designed for bonding with any one of a number of solvents, but other adhesive systems may be used. When solvent bonding, use a very small gauge needle (typically 27 or 30) for best solvent control. Consult your adhesive specialist for guidance on other systems.

Apply solvent sparingly. Most solvents are low viscosity and readily wick into the bondline. Excessive solvent may compromise the aesthetics and the function of the assembly.

Press the mating components together leaving a .01-.03" gap between them for the solvent. Place the components in an orientation such that they may be rotated ¼ turn to their final position after applying the solvent.

After applying solvent, wait a few seconds, then rotate the components to their final position. When making a long manifold with bondable junction blocks it may be helpful to push the assembly against a flat surface to align the blocks before the solvent has set.

Affordable Unique Solutions:

Design Your New Component with Build-A-Part® Bondable Components!

Component designers no longer need to be constrained by the limitations of injection molding tool design. The exact fitting, in the optimal layout for the process or product concept, is now available with Nordson MEDICAL's line of Build-a-Part® bondable components, designed for use with gases or liquids.

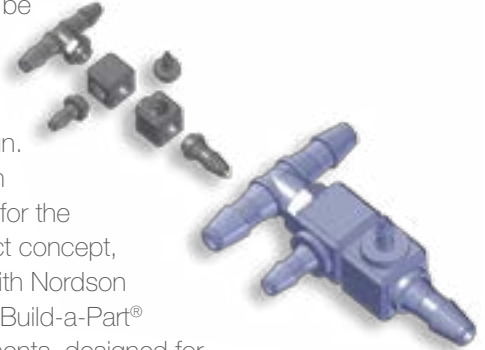

The Build-a-Part® system is based on combining interchangeable components, joining junction blocks and luers, hose barbs or threaded features to create the desired configuration. The features are bonded to the junction blocks using commonly available adhesives. Junction blocks and features may be bonded together to create multi-port, multi-axis products that receive and redirect fluid flow in whatever direction the designer desires. The only limitation is the designer's imagination.

114 component options are available from stock in two primary materials. Options include ISO 594-1 compliant male and female luers and hose barbs in 1/16" (1.6 mm), 3/32" (2.4 mm) and 1/8" (3.2 mm) in straight, elbow and branch tee configurations. Also available are male threads including 10-32 UNF, 1/16-27 NPT, 1/8-27 NPT, 1/4-28 UNF and M6x1 versions, and mounting devices.

The complete range is available in two primary resins: white ABS or translucent polysulfone. For ease of testing concepts, Nordson MEDICAL offers designer kits in both resins. Each kit contains hundreds of components for prototype purposes, enabling designs to be created and modified prior to production commitment.

BLOCK	NUMBER	MATERIAL
Build-A-Part® Junction Blocks. See Configuration Table for specifications.		
	BDJ01-40	Polysulfone
	BDJ01-81	Lace White ABS
	BDJ02-40	Polysulfone
	BDJ02-81	Lace White ABS
	BDJ03-40	Polysulfone
	BDJ03-81	Lace White ABS
	BDJ04-40	Polysulfone
	BDJ04-81	Lace White ABS
	BDJ05-40	Polysulfone
	BDJ05-81	Lace White ABS
	BDJ06-40	Polysulfone
	BDJ06-81	Lace White ABS
	BDJ07-40	Polysulfone
	BDJ07-81	Lace White ABS
	BDJ08-40	Polysulfone
	BDJ08-81	Lace White ABS
	BDJ09-40	Polysulfone
	BDJ09-81	Lace White ABS
	BDJ10-40	Polysulfone
	BDJ10-81	Lace White ABS
	BDJ11-40	Polysulfone
	BDJ11-81	Lace White ABS
	BDJ12-40	Polysulfone
	BDJ12-81	Lace White ABS
	BDJ13-40	Polysulfone
	BDJ13-81	Lace White ABS
	BDJ14-40*	Polysulfone
	BDJ14-81*	Lace White ABS
	BDJ15-40*	Polysulfone
	BDJ15-81*	Lace White ABS

BLOCK	NUMBER	MATERIAL
Build-A-Part® Junction Blocks with Mounting Port. See Configuration Table for specifications.		
	BDJ16-40*	Polysulfone
	BDJ16-81*	Lace White ABS
	BDJ17-40*	Polysulfone
	BDJ17-81*	Lace White ABS
	BDJ18-40	Polysulfone
	BDJ18-81	Lace White ABS
	BDJ19-40	Polysulfone
	BDJ19-81	Lace White ABS
	BDJ20-40	Polysulfone
	BDJ20-81	Lace White ABS
	BDJ21-40	Polysulfone
	BDJ21-81	Lace White ABS
	BDJ22-40	Polysulfone
	BDJ22-81	Lace White ABS

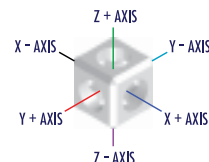

Build-A-Part® Junction Block Configuration Table

BLOCK	X+ AXIS	X- AXIS	Y+ AXIS	Y- AXIS	Z+ AXIS	Z- AXIS
BDJ01	Female	Female				
BDJ02			Female		Female	
BDJ03			Female		Female	Female
BDJ04	Female	Female	Female	Female		
BDJ05	Female		Female		Female	
BDJ06	Female		Female		Female	Female
BDJ07	Female	Female	Female	Female	Female	
BDJ08	Female	Female	Female	Female	Female	Female
BDJ09	Male	Female	Female		Female	Female
BDJ10	Male	Female	Female	Female	Female	Female
BDJ11	Male	Female	Female	Female		
BDJ12	Male	Female	Female			
BDJ13	Male	Female	Female			Female
BDJ14	Male	Female				
BDJ15	Female	Female				
BDJ16	Female	Female		Female ^a		
BDJ17	Male	Female	Female ^a			
BDJ18	Male ^b	Female	Female		Female	Female
BDJ19	Male ^b	Female	Female	Female	Female	Female
BDJ20	Male ^b	Female	Female	Female		
BDJ21	Male ^b	Female	Female			
BDJ22	Male ^b	Female	Female			Female

*Check valve junction block. For use with RB01 and SB01

^aFor non-flow manifolding ^bFor use with BDMD

RB01 (-X2) SB01 (-X0)

Check Valve Ball 5/32" Diameter

**BDMRP (-40 -81)**

Bondable Plug

**BDMD (-40 -81)**

Bondable Mounting Device

**BDMFTLL (-40 -81 -9)**

Bondable Female Luer Thread Style

**BDMMTL (-40 -81)**

Bondable Male Luer (May be used with separate rotating lock ring; RMLLR)

**RMLLR (-1 -2 -3 -4 -5 -06 -07 -6005 -9 -9002 -J1A)**

Rotating Male Luer Lock Ring (For use with BDMMTL)

**BDMR210 (-40 -81 -9 -9002)**

Bondable 200 Series Barb, 1/16" (1.6 mm) ID Tubing

**BDMR410 (-40 -81)**

Bondable 400 Series Barb, 1/16" (1.6 mm) ID Tubing

**BDMR220 (-40 -81)**

Bondable 200 Series Barb, 3/32" (2.4 mm) ID Tubing

**BDMR420 (-40 -81)**

Bondable 400 Series Barb, 3/32" (2.4 mm) ID Tubing

**BDMR230 (-40 -81)**

Bondable 200 Series Barb, 1/8" (3.2 mm) ID Tubing

**BDMR430 (-40 -81)**

Bondable 400 Series Barb, 1/8" (3.2 mm) ID Tubing

**BDMR240 (-40 -6005 -81)**

Bondable 200 Series Barb, 5/32" (4.0 mm) ID Tubing

**BDMR445 (-40 -81)**

Bondable 400 Series Barb, .170" (4.3 mm) ID Tubing

**BDML210 (-40 -81 -9)**

Bondable Elbow 200 Series Barb, 1/16" (1.6 mm) ID Tubing

**BDML410 (-40 -81)**

Bondable Elbow 400 Series Barb, 1/16" (1.6 mm) ID Tubing

**BDML220 (-40 -81 -9)**

Bondable Elbow 200 Series Barb, 3/32" (2.4 mm) ID Tubing

**BDML420 (-40 -81)**

Bondable Elbow 400 Series Barb, 3/32" (2.4 mm) ID Tubing

**BDML230 (-40 -81)**

Bondable Elbow 200 Series Barb, 1/8" (3.2 mm) ID Tubing

**BDML430 (-40 -81)**

Bondable Elbow 400 Series Barb, 1/8" (3.2 mm) ID Tubing



BUILD-A-PART®:

Tees

BDMT210 (-40 -81)

Bondable Tee 200 Series Barb, 1/16" (1.6 mm) ID Tubing



BDMT410 (-40 -81)

Bondable Tee 400 Series Barb, 1/16" (1.6 mm) ID Tubing



BDMT220 (-40 -81)

Bondable Tee 200 Series Barb, 3/32" (2.4 mm) ID Tubing



BDMT420 (-40 -81)

Bondable Tee 400 Series Barb, 3/32" (2.4 mm) ID Tubing



BDMT230 (-40 -81)

Bondable Tee 200 Series Barb, 1/8" (3.2 mm) ID Tubing



BDMT430 (-40 -81)

Bondable Tee 400 Series Barb, 1/8" (3.2 mm) ID Tubing



BUILD-A-PART®:

Threads

BDMK (-40 -81)

Bondable 10-32 UNF Thread with 1/4" Hex



BDMX (-40 -81)

Bondable 10-32 Special Tapered Thread with 1/4" Hex



BDMS (-81)

Bondable 1/4-28 UNF Thread with 5/16" Hex



BDMM6 (-40 -81)

Bondable M6x1 Thread with 5/16" Hex



BDM16 (-40 -81)

Bondable 1/16-27 NPT Thread with 5/16" Hex



BDM18 (-40 -81)

Bondable 1/8-27 NPT Thread with 7/16" Hex



BDF16 (-40 -81)

Bondable 1/16-27 NPT Thread with 5/16" Hex



BDF18 (-40 -81)

Bondable 1/8-27 NPT Thread with 7/16" Hex



BDFM6 (-40 -81)

Bondable M6x1 Thread with 5/16" Hex



BDFS (-40 -81)

Bondable 1/4-28 UNF Thread with 5/16" Hex



Need it Fast?

You can order any of our 4,000+ parts online now with no order \$ minimums, 24 hours a day, 7 days a week!

www.nordsonmedical.com

TUBING

Medical Grade



Polyvinyl Chloride (PVC) Tubing
PG-102



Polyurethane Tubing
PG-103



Low Density Polyethylene Tubing
PG-103



Silicone Tubing
PG-103



Thermoplastic Elastomer (TPE) Tubing
PG-103



TUBING: Polyvinyl Chloride (PVC)

75 Durometer

Our PVC tubing is a very cost effective product that can satisfy a broad array of end use applications. It is flexible in nature, optically clear, and easily sterilized.

Resin Grade & Technical Information:

This tubing is extruded from Teknor® PVC80-NP resin, which is in compliance with all US Food & Drug Administration regulations for food grade use under Title 21 CFR. It is also certified USP Class VI. It can be sterilized by gamma radiation or Ethylene Oxide (EtO) gas. This tubing is not autoclavable.

DIMENSION (ID X OD X LGTH)	NUMBER
1/16" X 1/8" X 100'	PV00-1031C
1/16" X 1/8" X 1000'	PV00-1031M
3/32" X 3/16" X 100'	PV00-2047C
1/8" X 1/4" X 100'	PV00-3062C
1/8" X 1/4" X 1000'	PV00-3062M
3/16" X 5/16" X 100'	PV00-5062C
1/4" X 3/8" X 100'	PV00-6062C

Technical Assistance

Trying to choose the correct part? Need more material information than is published in this catalog? Call Nordson MEDICAL Technical Support **(970) 267-5200**.

Need Samples for Evaluation?

You can call to request most of our standard product in quantities of 5, or less, for free application evaluation.
+1 (970) 267-5200 Toll Free: (888) 404-5837

TUBING:
Polyurethane

80 Durometer

Our polyurethane tubing is extremely kink resistant. It is also highly resistant to abrasion and scuffing. It is widely accepted as a premium material for medical device use because of its flexible nature and easy sterilizability.

Resin Grade & Technical Information:

This tubing is extruded from Lubrizol's® compound Pellethane PUR80A-MED, which has passed USP Class VI testing. It can be sterilized by gamma radiation or Ethylene Oxide (EtO) gas. Please do not autoclave this tubing, as it may alter the chemical nature of the resin.

DIMENSION (ID X OD X LGTH)	NUMBER
1/16" X 1/8" X 100'	UR00-1031C
1/16" X 1/8" X 1000'	UR00-1031M
3/32" X 3/16" X 100'	UR00-2047C
3/32" X 3/16" X 1000'	UR00-2047M
1/8" X 1/4" X 100'	UR00-3062C

TUBING:
Low Density Polyethylene

92 Durometer

Our polyethylene tubing has excellent mechanical and chemical resistance properties. However, please use caution if your application involves possible bending or kinking the tubing. It is a semi-rigid material and will be permanently deformed if kinked or bent too tight.

Resin Grade & Technical Information:

This tubing is extruded from Equistar® LLDPE, which is in compliance with all U.S. Food & Drug Administration regulations for food grade use under Title 21 CRF. It can be sterilized by gamma radiation or Ethylene Oxide (EtO) gas. Autoclaving is not recommended.

DIMENSION (ID X OD X LGTH)	NUMBER
1/16" X 1/10" X 100'	LLDPE01-1019C
1/16" X 1/10" X 1000'	LLDPE01-1019M
1/16" X 1/8" X 100'	LLDPE01-1031C
1/16" X 1/8" X 1000'	LLDPE01-1031M
3/32" X 5/32" X 100'	LLDPE01-2031C
3/32" X 5/32" X 1000'	LLDPE01-2031M
1/8" X 3/16" X 100'	LLDPE01-3031C
1/8" X 3/16" X 1000'	LLDPE01-3031M

TUBING:
Silicone

50 Shore A

Our silicone tubing is extruded from a low-volatile grade, platinum-cured compound that is ideal for critical applications in pharmaceutical, biotech, medical, food, and beverage industries.

Resin Grade & Technical Information:

This tubing is extruded and packaged in a Class 7 (Class 10,000) ISO-certified clean room. It has undergone extensive physical, chemical, and biological testing and meets USP Class VI, FDA CFR 177.2600, ISO 10993, European Pharmacopoeia 3.1.9, and 3-A standards. It is certified free of animal-derived ingredients and is certified by the National Sanitation Foundation for use in food equipment materials (NSF-51). It offers a temperature range use of -100° F (-73.3° C) to 400° F (204.4° C) and is sterilizable by autoclave or gamma irradiation.

DIMENSION (ID X OD X LGTH)	NUMBER
1/16" X 1/8" X 50'	SILC7001098
1/8" X 1/4" X 50'	SILC7001657
1/4" X 3/8" X 50'	SILC7002203
3/8" X 5/8" X 50'	SILC7002593
1/2" X 3/4" X 50'	SILC7002775
3/4" X 1" X 50'	SILC7003139

TUBING:
Thermoplastic Elastomer (TPE)

65 Shore A

Our Biopharmaceutical-grade TPE tubing is sterile weldable, heat sealable, moldable, and offers excellent life in peristaltic pumps. It is ideal for use in single-use processes for sampling, filling, and storage tubing set assemblies.

Resin Grade & Technical Information:

This tubing is made from FDA-approved ingredients, certified free of silicone oils and animal derived ingredients, and is sterilizable by autoclave or gamma irradiation. It meets various ISO and USP standards, including Class VI, as well as European Pharmacopoeia 3.2.2.1. It also offers excellent low absorption and permeability as compared to silicone tubing.

DIMENSION (ID X OD X LGTH)	NUMBER
1/8" X 1/4" X 50'	AF7500077
3/16" X 5/16" X 50'	AF7500155
1/4" X 7/16" X 50'	AF7500311
3/8" X 5/8" X 50'	AF7500506
1/2" X 3/4" X 50'	AF7500584
3/4" X 1" X 50'	AF7500753

TUBING

OTHER

Components

Tapered Seal
PG-104



Clamps
PG-106



Injection Sites
PG-106



Spikes
PG-106



Tubesetter® Assembly Tool
PG-107



Designer Kits
PG-108



TSC Series

Tapered Seal

With TSC Series conical seal fittings, Nordson MEDICAL expands its range of products for small-bore connector applications in medical devices. TSC Series products offer the reliability, convenience and ease of use of luer fittings in a design that cannot be interconnected with conventional luers and avoid tubing misconnections. These luer alternatives are available in sizes to fit 1/8" (3.2 mm) and 3/16" (4.8 mm) ID flexible tubing.

Features & Benefits:

- Ergonomic grip
- Conical (tapered) seal
- 15% higher flow capacity than conventional luers
- Polypropylene resin
- Cannot interconnect with conventional luers taper fittings
- 500 Series single barbs

SMALL BORE CONNECTORS:

Male

TSC2M210 (-6005)

Male Taper Seal Non-Luer Connector to 200 Series Barb, 1/16" (1.6 mm) ID Tubing



TSC2M013 (-6005)

Male Taper Seal Non-Luer Connector to 500 Series Barb, 1/8" (3.2 mm) ID Tubing



TSC2M035 (-6005)

Male Taper Seal Non-Luer Connector to 500 Series Barb, 3/16" (4.8 mm) ID Tubing



SMALL BORE CONNECTORS:

Female

TSC2F210 (-6005)

Female Taper Seal Non-Luer Connector to 200 Series Barb, 1/16" (1.6 mm) ID Tubing



TSC2F007 (-6005)

Female Taper Seal Non-Luer Connector to 500 Series Barb, 3/32" (2.4 mm) ID Tubing



TSC2F013 (-6005)

Female Taper Seal Non-Luer Connector to 500 Series Barb, 1/8" (3.2 mm) ID Tubing



TSC2F035 (-6005)

Female Taper Seal Non-Luer Connector to 500 Series Barb, 3/16" (4.8 mm) ID Tubing



TSC2FB230 (-6005)

Female Taper Seal Non-Luer with 1/4-28 UNF Panel Mount to 200 Series Barb, 1/8" (3.2 mm) ID Tubing



Small BORE CONNECTORS:

Plugs and Caps

TSC2MP (-6005) 1,000 piece minimum

Male Taper Seal Non-Luer Plug with Tether Recess



LARGE BORE CONNECTORS:

Male

MLB035 (-1 -8012 -9)

Male Large Bore Non-Luer Connector to 500 Series Barb, 3/16" (4.8 mm) ID Tubing



MLB055 (-1 -8012 -9)

Male Large Bore Non-Luer Connector to 500 Series Barb, 1/4" (6.4 mm) ID Tubing



MLB065 (-1 -8012 -9)

Male Large Bore Non-Luer Connector to 500 Series Barb, 5/16" (8.0 mm) ID Tubing



MLBC7 (-9002)

Male Large Bore Non-Luer Connector with Integral Lock Ring to Male Slip Luer (May be used with separate rotating lock ring; FSLLR)



MLBC8 (-9002)

Male Large Bore Non-Luer Connector with Integral Lock Ring to Female Thread-Style Locking Luer

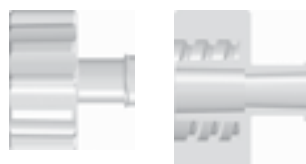

Need it Fast?

You can order any of our 4,000+ parts online now with no order \$ minimums, 24 hours a day, 7 days a week!

www.nordsonmedical.com

LARGE BORE CONNECTORS:

Female

FLB035 (-1 -8012 -9)

Female Large Bore Non-Luer Connector to 500 Series Barb, 3/16" (4.8 mm) ID Tubing

**FLB055 (-1 -2 -8012 -9)**

Female Large Bore Non-Luer Connector to 500 Series Barb, 1/4" (6.4 mm) ID Tubing

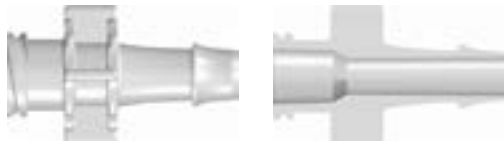
**FLB065 (-1 -8012 -9)**

Female Large Bore Non-Luer Connector to 500 Series Barb, 5/16" (8.0 mm) ID Tubing

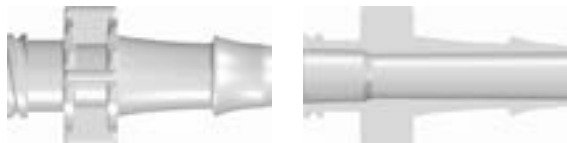
**LARGE BORE CONNECTORS:**

Plugs and Caps

FLBP (-1 -8012 -9)

Female Large Bore Non-Luer Cap

**MLBP (-1 -2 -8012 -9 -9002)**

Male Large Bore Non-Luer Plug

**OTHER COMPONENTS:**

Components

VPM2930601N (White ABS)

Tube Clamp with Split, 1/8" (3.2 mm) OD Tubing

**VPS3901074N (Polyisoprene with ABS Acrylic Body)**

IN-4000 Intermittent Injection Site to Male Luer Lock

**VPM1060200N (Clear Low Density Polyethylene)**

Long Spike Guard Closed at Tip

**VPM0480201N (White Polyethylene)**

Luer Tip Syringe Cap

**VPB0850400N (Clear ABS)**

Female Luer Thread Style Coupler

**VPM1080303N (Blue Polyethylene)**

Male Luer Integral Lock Ring Plug

**VPS5069200N (White ABS Spike with Clear LDPE Guard)**

Bag Spike with Vented Guard (Replaces VPS5069700N)



MANUAL TUBESETTER®

Designed for rapid assembly of barb to tube connections, the Tube setter® assembly tool joins flexible tubing and Nordson MEDICAL's barbed fitting, applying the force necessary to push the tube over the barb. No external power source is needed. Made almost entirely of acetal plastic, the device is easy to clean and suitable for operation in most environments. Consider the Manual Small Fitting Tube setter® assembly tool for prototype assembly or lower-volume manufacturing needs.

Nordson MEDICAL's Tube setter® assembly tool sets the standard for effortless tube set production. The Tube setter® product joins flexible tubing and Nordson MEDICAL's barbed fitting, applying the force necessary to push the tube over the barb, providing efficiency, economy and ease of use over other connection alternatives without adhesives or solvents!

Manual Tube setter®:

- Easy to use
- Excellent for volumes up to 1,000 assemblies per month
- Accommodates tubing from 3/32" to 3/8" OD
- Configurable for: Luers - Straights - Ys - Tees - Elbows
- Requires no electricity or pneumatic power
- Long-life acetal construction



PART	DESCRIPTION
930B1A	Manual TUBESETTER® Base
930JS*	Standard Jaw Set
930AS*	Standard Flip Top Anvil
920PS*	Standard Pin Set Assembly

*The base manual TUBESETTER® unit requires a jaw set, anvil assembly and pin set assembly. An additional engineering fee may be required for a custom application.

Custom Assembly

We produce standard components to fit your current assemblies and devices, but we also provide custom solutions by applying a variety of assembly options, such as joining fittings, connectors, filters, and other components to tubing. From systems using a single fitting to complex configurations utilizing various components, we can design complete assemblies to your requirements.

Technical Assistance

Trying to choose the correct part? Need more material information than is published in this catalog? Call Nordson MEDICAL Technical Support **(970) 267-5200**.

Need More Details?

Part drawings, minimum order quantities, and CAD requests can be found online. Visit www.nordsonmedical.com or contact Sales at sales@nordsonmedical.com.

OTHER COMPONENTS

ASSORTED DESIGNER KIT (Part number - ASSORTED KIT-001)

Our Assorted Kit provides a cross section of many components designed and manufactured by Nordson MEDICAL. This kit contains a variety of our popular components, including luers, tube-to-tube and threaded fittings. Please see www.nordsonmedical.com for a complete list of all included parts.



Note: Due to our ever increasing product line, Kit contents are subject to change without notice. Kits may include one or more of each component in a variety of materials.

LUER DESIGNER KIT (Part Number - LUER KIT-001)

Our Luer Kit contains male and female luers, luer plugs, couplers, tees, elbows as well as blood pressure cuff and monitor fittings. Luer tapers are made to ISO standards. Please see www.nordsonmedical.com for a complete list of all included parts.



Note: Due to our ever increasing product line, Kit contents are subject to change without notice. Kits may include one or more of each component in a variety of materials.

TUBE-TO-TUBE DESIGNER KIT (Part Number - TUBE-TO-TUBE KIT-001)

Our Tube-to-Tube Kit contains a variety of fittings in different configurations - and one that is sure to work for your application. Some of the fittings contained in this kit include straight-thru connectors, tees, elbows, Ys, and press-in plugs. Please see www.nordsonmedical.com for a complete list of all included parts.



Note: Due to our ever increasing product line, Kit contents are subject to change without notice. Kits may include one or more of each component in a variety of materials.

XQ DESIGNER KIT (Part Number - XQ KIT-001)

Our XQ Kit contains an assortment of XQ Series Quick Connect Fittings (Quick Disconnect Couplings). Please see www.nordsonmedical.com for a complete list of all included parts.



Note: Due to our ever increasing product line, Kit contents are subject to change without notice. Kits may include one or more of each component in a variety of materials.

BLOOD PRESSURE DESIGNER KIT (Part Number - BP KIT-001)

Our Blood Pressure Kit contains a variety of blood pressure fittings that are manufactured by Nordson MEDICAL. Some of the fittings contained in this kit include quick connect fittings, connectors, panel mounts and adaptors. Please see www.nordsonmedical.com for a complete list of all included parts.



Note: Due to our ever increasing product line, Kit contents are subject to change without notice. Kits may include one or more of each component in a variety of materials.

BIOPHARM DESIGNER KIT (Part Number - BIOPHARM KIT-001)

Our Biopharm Designer Kit contains a variety of fittings that are commonly found within the BioPharm market. Some of the fittings contained in this kit include our larger fittings of Y's, T's, elbows, straight through and reducing connectors ranging from 3/8" to 1", sanitary fittings, clamps, quick connects and gaskets. Please see www.nordsonmedical.com for a complete list of all included parts.



Note: Due to our ever increasing product line, Kit contents are subject to change without notice. Kits may include one or more of each component in a variety of materials.

BUILD-A-PART DESIGNER KIT (Part Number - KIT01-81 -KIT01-40)

Our Build-A-Part Kits are available in two different materials: White ABS or Polysulfone. Contained in these kits are luers, elbows, tees, and junction blocks. Please see www.nordsonmedical.com for a complete list of all included parts.



Note: Due to our ever increasing product line, Kit contents are subject to change without notice. Kits may include one or more of each component in a variety of materials.

INK JET DESIGNER KIT (Part Number - INK JET KIT-001)

A cross section of many components designed and manufactured by Nordson MEDICAL. Includes luers, tube-to-tube and threaded fittings commonly used by Ink Jet Printer Manufacturers. Please see www.nordsonmedical.com for a complete list of all included parts.



Note: Due to our ever increasing product line, Kit contents are subject to change without notice. Kits may include one or more of each component in a variety of materials.

TECHNICAL

Information



Barb Dimensions PG-110

Barb Performance PG-112

TECHNICAL: Barb Dimensions

The **CLASSIC SERIES** is characterized by a longer barb that extends the sealing surface of the fitting. Tubing is expanded from 42% to 69% above its nominal ID.



Barb Size	Barb OD	Barb ID	Tube Internal Diameter		
			Dec.	Frac.	Metric
10	0.105	0.046	0.063	1/16"	1.6 mm
20	0.145	0.060	0.094	3/32"	2.4 mm
30	0.187	0.078	0.125	1/8"	3.2 mm
40	0.234	0.100	0.156	5/32"	4.0 mm
50	0.280	0.130	0.188	3/16"	4.8 mm
60	0.355	0.187	0.250	1/4"	6.4 mm

BPF Series Performance PG-113

Panel Mount Instructions PG-113

The **200 SERIES** offers outstanding performance characteristics when used with flexible tubing. Tubing is expanded by 50% above its nominal ID, permitting high-pressure capabilities.

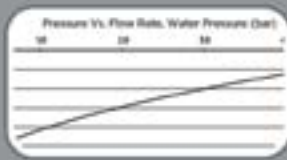

Barb Size	Barb OD	Barb ID	Tube Internal Diameter		
			Dec.	Frac.	Metric
210	0.094	0.047	0.063	1/16"	1.6 mm
220	0.141	0.070	0.094	3/32"	2.4 mm
230	0.188	0.094	0.125	1/8"	3.2 mm
240	0.234	0.117	0.156	5/32"	4.0 mm
250	0.282	0.141	0.188	3/16"	4.8 mm
260	0.375	0.188	0.250	1/4"	6.4 mm

Resin Information PG-114

Trademarks PG-117

The **300 SERIES** offers outstanding performance characteristics when used with flexible tubing. Tubing is expanded by 35% above its nominal ID, permitting high-pressure capabilities in the larger tube sizes.

CHEMICAL	%	TEMP C	TEMP F	GR.
Acetic Acid	25	25.1	77.1	Grade 1
Acetone	100	50.1	122.1	Grade 1
Acrylonitrile	100	24.1	75.1	Grade 1
Acrylonitrile	100	24.1	75.1	Grade 1
Air	100	21.1	70.1	Grade 1
Ammonia Liquid	100	24.1	75.1	Grade 1



Barb Size	Barb OD	Barb ID	Tube Internal Diameter		
			Dec.	Frac.	Metric
360	0.338	0.192	0.250	1/4"	6.4 mm

Index PG-118

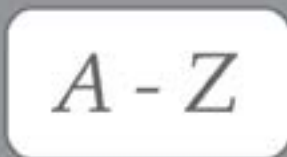

*Variations of barb IDs may exist. Please visit www.nordsonmedical.com to learn more about these alternatives. The data presented here is for reference only. It was compiled to provide our customers with a means of comparing the characteristics of components at the time of publication. The particular conditions of your use and application of our products are beyond our control. Thus, it is imperative that you test our products in your specific application to determine their suitability. All information is provided without implied or express warranty or guarantee by Nordson MEDICAL or other manufacturers. None of the information provided constitutes a recommendation or endorsement of any kind by Nordson MEDICAL.

The **400 SERIES** provides easy assembly while maintaining excellent pressure and tensile capabilities. Originally created for semi-rigid tubing, this series is preferred for applications where tensile/pressure properties are not highly critical, or when ease of assembly is desired. The 400 Series expands the tubing 25% above its nominal ID.



Barb Size	Barb OD	Barb ID	Tube Internal Diameter		
			Dec.	Frac.	Metric
410	0.078	0.046	0.063	1/16"	1.6 mm
420	0.117	0.068	0.094	3/32"	2.4 mm
430	0.156	0.092	0.125	1/8"	3.2 mm
440	0.206	0.125	0.156	5/32"	4.0 mm
445	0.213	0.125	0.170	-	4.3 mm
450	0.234	0.137	0.188	3/16"	4.8 mm
460	0.313	0.184	0.250	1/4"	6.4 mm

The **500 SERIES** profile is composed of blended radii, giving it the distinct look. Each barb is designed to accommodate a range of tube sizes and tube types. Consideration should be given to flow restriction, pressure capability, and the force required for assembly of the tube.



Barb Size	Barb OD	Barb ID*	Tube Internal Diameter		
			Dec.	Frac.	Metric
004	0.102	0.060	0.063	1/16"	1.6 mm
007	0.129	0.076	0.094	3/32"	2.4 mm
013	0.164	0.096	0.125	1/8"	3.2 mm
025	0.208	0.122	0.156	5/32"	4.0 mm
035	0.264	0.155	0.188	3/16"	4.8 mm
055	0.335	0.197	0.250	1/4"	6.4 mm
065	0.425	0.250	0.312	5/16"	8.0 mm
N070	0.483	0.262	0.375	3/8"	9.5 mm
L070	0.483	0.251	0.375	3/8"	9.5 mm
T070	0.483	0.290	0.375	3/8"	9.5 mm
Y070	0.483	0.290	0.375	3/8"	9.5 mm
N080	0.613	0.333	0.500	1/2"	12.7 mm
L080	0.613	0.319	0.500	1/2"	12.7 mm
T080	0.613	0.356	0.500	1/2"	12.7 mm
Y080	0.613	0.362	0.500	1/2"	12.7 mm
N090	0.718	0.390	0.625	5/8"	16.0 mm
L090	0.718	0.374	0.625	5/8"	16.0 mm
T090	0.718	0.374	0.625	5/8"	16.0 mm
Y090	0.718	0.390	0.625	5/8"	16.0 mm
N100	0.853	0.465	0.750	3/4"	19.0 mm
L100	0.853	0.443	0.750	3/4"	19.0 mm
T100	0.853	0.447	0.750	3/4"	19.0 mm
Y100	0.853	0.492	0.750	3/4"	19.0 mm
N110	1.125	0.623	1.000	1"	25.4 mm
L110	1.125	0.600	1.000	1"	25.4 mm
T110	1.125	0.600	1.000	1"	25.4 mm
Y110	1.125	0.623	1.000	1"	25.4 mm

The **600 SERIES** barbs are designed for use with silicone, C-Flex® and PVC tubing sizes commonly used in biopharm and other applications. Tubing is expanded from 18% to 34% above its nominal ID to maintain a low profile and ease of assembly, and the straight barb stem facilitates use of recommended cable tie retainers or hose clamps.



Barb Size	Barb OD	Barb ID*	Tube Internal Diameter		
			Dec.	Frac.	Metric
630	0.188	0.085	0.125	1/8"	3.2 mm
655	0.335	0.181	0.250	1/4"	6.4 mm
670	0.490	0.296	0.375	3/8"	9.5 mm
680	0.625	0.403	0.500	1/2"	12.7 mm
690	0.762	0.499	0.625	5/8"	16.0 mm
6100	0.900	0.615	0.750	3/4"	19.0 mm
6110	1.180	0.804	1.000	1"	25.4 mm

The **700 SERIES** barb is designed for use with Nordson MEDICAL's XQ Series quick connect fittings. This unique single barb is available in sizes to fit the 1/4" (6.4 mm), 5/16" (7.9 mm) and 3/8" (9.5 mm) ID tubing sizes and materials commonly used in disposable and reusable medical equipment. Reinforced PVC, unreinforced PVC and polyurethane tubing materials work well with this barb style.



Barb Size	Barb OD	Barb ID	Tube Internal Diameter		
			Dec.	Frac.	Metric
755	0.329	0.204	0.250	1/4"	6.4 mm
765	0.398	0.245	0.312	5/16"	7.9 mm
770	0.455	0.302	0.375	3/8"	9.5 mm

The **900 SERIES** offers outstanding performance characteristics when used with flexible tubing. Tubing is expanded from 8% to 17% above its nominal ID. This barb provides high flow efficiency and excellent tensile strength. A hose clamp is recommended for this series.



Barb Size	Barb OD	Barb ID	Tube Internal Diameter		
			Dec.	Frac.	Metric
970	0.437	0.269	0.375	3/8"	9.5 mm
975	0.573	0.358	0.500	1/2"	12.7 mm

The **3200 SERIES** is designed for semi-rigid tubing and is preferred for applications where stiffer tubing, like Polyurethane and thicker PVC tubing with harder durometers, is generally used. The 3200 Series expands the tubing between 20% and 50% above its nominal inside diameter and is designed for use with Nordson MEDICAL's PQC Series quick connect fittings. This unique triple barb is available in sizes to fit the 1/8" (3.2 mm) and 1/4" (6.4 mm) ID tubing sizes and materials commonly used in medical device and diagnostics, chemical dispensing, industrial, and compression therapy applications.



Barb Size	Barb OD	Barb ID	Tube Internal Diameter		
			Dec.	Frac.	Metric
3230	0.188	0.059	0.500	1/8"	3.2 mm
3260	0.300	0.150	0.200	1/4"	6.4 mm

Tensile pull and burst tests were performed by an independent laboratory under controlled conditions to provide comparative performance data for the various barb styles and sizes offered by Nordson MEDICAL. Graph numbers 1 through 8 present the data from each of the tests for each barb size and each barb style connected to PVC tube.

The values shown are the means of a statistically significant sample quantity of each configuration. Nordson MEDICAL barbed fittings specifically designed for use with the tubing size indicated were used in these tests. No oversized barbs, solvents, adhesives, or secondary fasteners of any kind were used.

Tensile Pull Test: Tensile properties were measured to determine the force required to remove the barbed fitting from the tubing. Tensile specimens were mounted axially in a holding fixture and tested at a rate of 20 inches per minute. Failure mode was tubing separating from the barb.

Hydrostatic Burst Test: Hydrostatic burst testing was performed in general accordance with ASTM D1599. Failure mode was either tubing separating from the barb, the tubing bursting, or a combination of the two.

Performance of Barb to Tube Connections - ■ Tensile Pull Test (lbs) - ■ Hydrostatic Burst Test (psi)

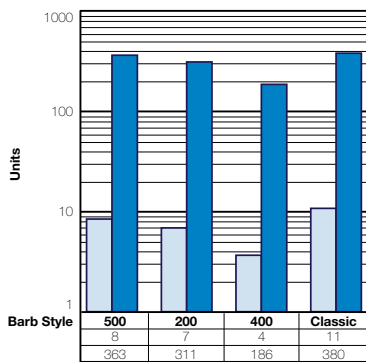

Graph 1: 1/16" Barb Performance

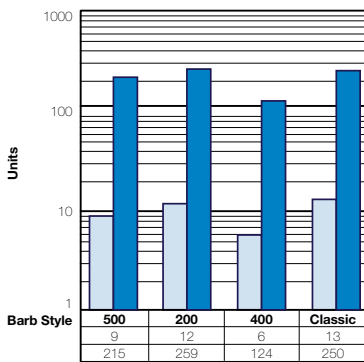

Graph 2: 3/32" Barb Performance

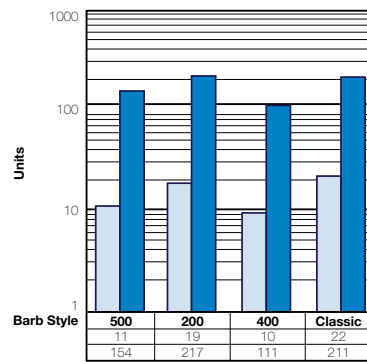

Graph 3: 1/8" Barb Performance

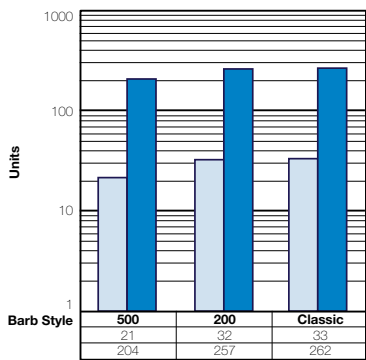

Graph 4: 5/32" Barb Performance

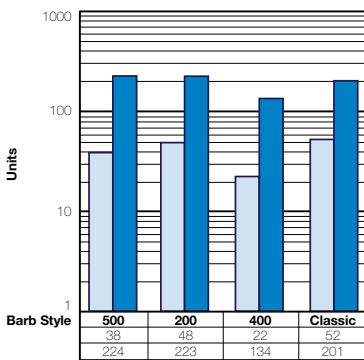

Graph 5: 3/16" Barb Performance

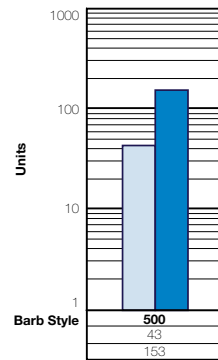

Graph 6: 1/4" Barb Performance

600 Series Leak Tests

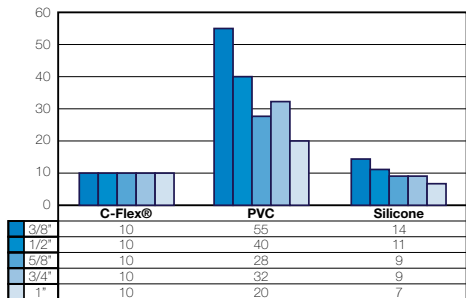

600 Series Tensile Pull Tests

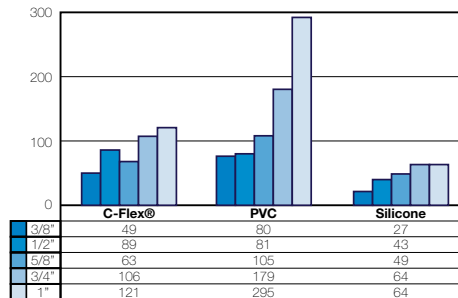

The data presented here is for reference only. It was compiled to provide our customers with a means of comparing the characteristics of components at the time of publication. The particular conditions of your use and application of our products are beyond our control. Thus, it is imperative that you test our products in your specific application to determine their suitability. All information is provided without implied or express warranty or guarantee by Nordson MEDICAL or other manufacturers. None of the information provided constitutes a recommendation or endorsement of any kind by Nordson MEDICAL.

Maximum cycles _____ 50,000 connect-disconnect cycles

Maximum leak resistance _____ < .007 psi / 0.05 kPa / sec.

Maximum axial tensile resistance _____ 20 lbf.

Minimum Fitting ID _____ .113" / 2.9 mm

Maximum working pressure _____ 60 psi, 4.14 bar

Minimum Cv _____ .39

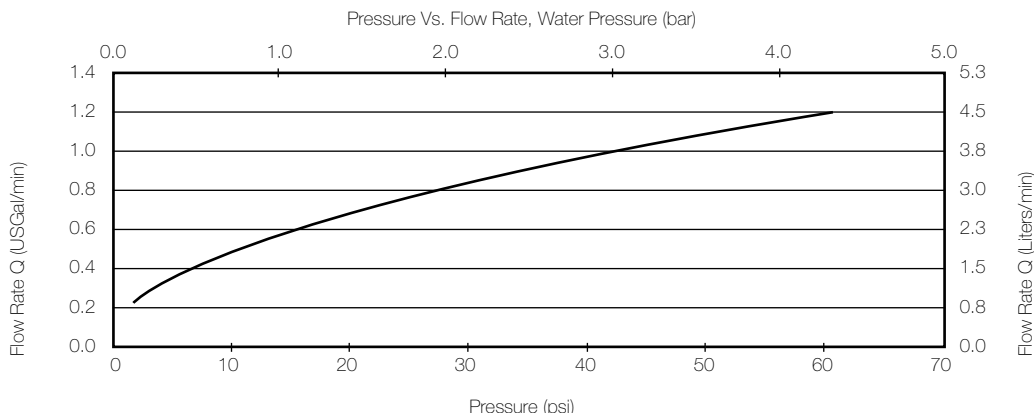

TECHNICAL:

Panel Mount Instructions

Panel-mounted female luers, in both FTLLB (thread style) and FTLB (lug style) series, are shown beginning on page 66. When used with our CCLR lock rings or CCR color coding rings and LNS lock nuts (see pages 67, 87), color coding of connections is easy.

The information provided here will help you mount the panel mount luers. Please note that they are intended for panel thickness of 1/16" to 1/8" (1.5 to 3 mm).

FTLLB series shown with MLSL luer, FSLLR lock ring, CCLR color coding lock ring, and LNS lock nut.

Threaded Panel Openings: Tap the panel with threads from tube fittings, panel mounts or BPMBs and use a CCR color coded ring. In this case, the fitting tightened into the panel prevents fitting rotation. Use an LNS lock nut for additional security; tighten snug plus 1/4 turn only.

Non-Threaded Panel Openings: Use any one of the three panel patterns shown below with a CCLR lock ring and LNS lock nut. Together, the panel opening and CCLR prevent the panel mount fitting from rotating. Tighten LNS snug plus 1/4 turn only.

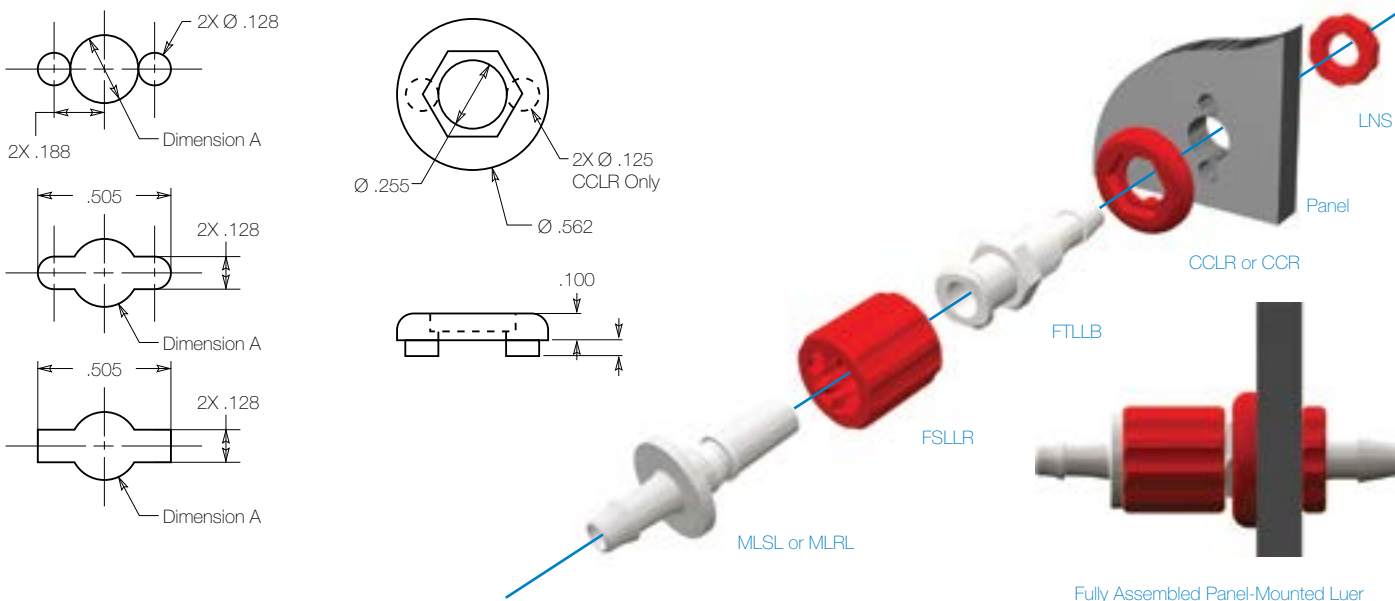

CHEMICAL	%	TEMP C	TEMP F	ABS	ACETAL	PVDF	NYLON	POLYCARBONATE	POLYPROPYLENE	POLYSULFONE
Acetic Acid	5%	23 C	73 F	Excellent	Unsatisfactory	Excellent	Satisfactory	Satisfactory	Excellent	Excellent
Acetone	100%	50 C	122 F	Unsatisfactory	Unsatisfactory	Unsatisfactory	Satisfactory	Unsatisfactory	Excellent	Unsatisfactory
Acetophenone	100%	24 C	75 F	Satisfactory	—	Unsatisfactory	Excellent	—	Satisfactory	—
Acetylene	100%	24 C	75 F	—	—	Excellent	Excellent	—	—	—
Air	100%	82 C	180 F	Excellent	Excellent	Excellent	Excellent	—	—	Excellent
Ammonia, Liquid	100%	24 C	75 F	Satisfactory	—	Unsatisfactory	Satisfactory	Unsatisfactory	Excellent	Satisfactory
Ammonium Hydroxide	10%	23 C	73 F	Satisfactory	—	Excellent	Excellent	Unsatisfactory	Excellent	Excellent
Ammonium Hydroxide	10%	70 C	158 F	Unsatisfactory	—	Excellent	Unsatisfactory	Unsatisfactory	Excellent	Excellent
Barium Sulfide	100%	24 C	75 F	Excellent	Excellent	Excellent	Satisfactory	—	Excellent	—
Benzene	100%	23 C	73 F	Satisfactory	Excellent	Excellent	Excellent	Unsatisfactory	Satisfactory	Unsatisfactory
Bleach	100%	23 C	73 F	—	Unsatisfactory	Excellent	Satisfactory	Unsatisfactory	Satisfactory	Excellent
Boric Acid	7%	35 C	95 F	Excellent	Excellent	Excellent	Unsatisfactory	Excellent	Excellent	—
Calcium Carbonate	Sat. sol.	24 C	75 F	Excellent	—	Excellent	—	—	Excellent	—
Carbon Dioxide	100%	50 C	122 F	Satisfactory	Excellent	Excellent	Excellent	—	Excellent	—
Carbon Monoxide	100%	50 C	122 F	Satisfactory	—	Excellent	Excellent	—	Excellent	—
Carbon Tetrachloride	100%	50 C	122 F	Unsatisfactory	—	Excellent	Excellent	Unsatisfactory	Unsatisfactory	Unsatisfactory
Chlorine Water	Dilute	23 C	73 F	Unsatisfactory	—	Excellent	Satisfactory	Unsatisfactory	Unsatisfactory	Satisfactory
Chlorine Water	Concen.	23 C	73 F	Unsatisfactory	—	Excellent	Unsatisfactory	Unsatisfactory	Unsatisfactory	Unsatisfactory
Chlorobenzene	100%	23 C	73 F	Satisfactory	—	Excellent	Excellent	Unsatisfactory	Unsatisfactory	Unsatisfactory
Chlorofluorocarbon 11	100%	24 C	75 F	—	—	Excellent	Excellent	Satisfactory	—	Excellent
Chloroform	100%	23 C	73 F	Unsatisfactory	Satisfactory	Excellent	Satisfactory	Unsatisfactory	Unsatisfactory	Unsatisfactory
Cyclohexanone	100%	24 C	75 F	Unsatisfactory	—	Excellent	Excellent	Unsatisfactory	Satisfactory	Unsatisfactory
Dichlorethylene	100%	23 C	73 F	—	—	Excellent	Satisfactory	—	Excellent	Unsatisfactory
Ethanol	95%	50 C	122 F	Satisfactory	—	Excellent	Excellent	Satisfactory	Excellent	Satisfactory
Ethyl Acetate	95%	50 C	122 F	Satisfactory	—	Unsatisfactory	Excellent	Unsatisfactory	Satisfactory	Unsatisfactory
Ethylene Glycol	100%	23 C	73 F	Excellent	Satisfactory	Excellent	Excellent	Satisfactory	Excellent	Excellent
Ethylene Oxide	100%	24 C	75 F	Unsatisfactory	—	Excellent	Satisfactory	Satisfactory	Satisfactory	Excellent
Ethylene Oxide	100%	79 C	175 F	Unsatisfactory	—	Excellent	Unsatisfactory	Satisfactory	Unsatisfactory	Excellent
Fatty Acids	—	—	—	—	Excellent	Excellent	—	Satisfactory	Excellent	—
Fluorine	100%	23 C	73 F	Unsatisfactory	—	Excellent	Unsatisfactory	—	—	—
Formaldehyde	37%	24 C	75 F	Unsatisfactory	Excellent	Excellent	—	Unsatisfactory	Excellent	Unsatisfactory
Gasoline	100%	85 C	185 F	Excellent	Satisfactory	Excellent	Excellent	Unsatisfactory	Satisfactory	Satisfactory
Glucose	Concen.	24 C	75 F	Excellent	—	Excellent	—	—	Excellent	—
Glycerin	100%	24 C	75 F	Excellent	—	Excellent	—	Excellent	Excellent	Excellent
Hydrochloric Acid	2%	23 C	73 F	Excellent	Satisfactory	Excellent	Excellent	Excellent	Excellent	Excellent
Hydrochloric Acid	10%	25 C	77 F	Excellent	Satisfactory	Excellent	Unsatisfactory	Excellent	Excellent	Excellent
Hydrofluoric Acid	10%	23 C	73 F	Satisfactory	—	Excellent	Unsatisfactory	—	Excellent	Excellent
Hydrogen Peroxide	1%	24 C	75 F	Excellent	Unsatisfactory	Excellent	Satisfactory	Excellent	Excellent	Excellent
Hydrogen Peroxide	5%	43 C	110 F	Satisfactory	Unsatisfactory	Excellent	Unsatisfactory	Excellent	Satisfactory	Excellent
Isopropanol	70%	23 C	73 F	—	Excellent	Excellent	Excellent	Call*	Excellent	Satisfactory
Kerosene	100%	85 C	185 F	Satisfactory	—	Excellent	Excellent	Satisfactory	Satisfactory	Satisfactory
Methyl Ethyl Ketone	100%	50 C	122 F	Unsatisfactory	—	Unsatisfactory	Excellent	Unsatisfactory	Satisfactory	Unsatisfactory
Methylene Chloride	100%	23 C	73 F	Unsatisfactory	—	Excellent	Satisfactory	Unsatisfactory	Excellent	Unsatisfactory
Methanol	100%	23 C	73 F	Unsatisfactory	—	Excellent	Excellent	Satisfactory	Excellent	Satisfactory
Nitric Acid	10%	23 C	73 F	Satisfactory	—	Excellent	Unsatisfactory	Unsatisfactory	Excellent	Satisfactory
Oxygen	100%	24 C	75 F	—	—	Excellent	Satisfactory	—	—	—
Ozone	100%	43 C	110 F	Satisfactory	—	Satisfactory	Unsatisfactory	Unsatisfactory	—	—
Phenol	90%	23 C	73 F	Unsatisfactory	Unsatisfactory	Excellent	Unsatisfactory	—	Excellent	—
Phosphoric Acid	5%	98 C	208 F	Satisfactory	Unsatisfactory	Excellent	Unsatisfactory	Unsatisfactory	Excellent	Excellent
Propane	100%	23 C	73 F	Satisfactory	—	Excellent	Excellent	—	—	—
Sodium Bicarbonate	Concen.	24 C	75 F	Excellent	Excellent	Excellent	Excellent	—	Excellent	Excellent
Sodium Chloride	10%	23 C	73 F	Excellent	—	Excellent	Excellent	—	Excellent	Excellent
Sodium Chloride	Sat. sol.	24 C	75 F	Excellent	—	Excellent	Excellent	—	Excellent	Excellent
Sodium Hydroxide	10%	70 C	158 F	Satisfactory	—	Excellent	Satisfactory	—	Excellent	Excellent
Steam	—	120 C	248 F	Unsatisfactory	—	Excellent	Unsatisfactory	Unsatisfactory	Satisfactory	Excellent
Sulfuric Acid	30%	23 C	73 F	Satisfactory	Unsatisfactory	Excellent	Unsatisfactory	Excellent	Excellent	Excellent
Tetrahydrofuran	100%	23 C	73 F	Satisfactory	—	Unsatisfactory	Excellent	—	Unsatisfactory	—
Toluene	100%	50 C	122 F	Satisfactory	Unsatisfactory	Excellent	Excellent	Unsatisfactory	Unsatisfactory	Unsatisfactory
Trichloroethylene	100%	23 C	73 F	Satisfactory	—	Excellent	Satisfactory	Unsatisfactory	Unsatisfactory	Unsatisfactory
Water	100%	79 C	175 F	Excellent	—	Excellent	Excellent	Unsatisfactory	Excellent	Excellent

* Call Nordson MEDICAL technical support to review your application and the concentration of Isopropanol that will be used.

The data presented here is for reference only. It was compiled to provide our customers with a means of comparing the characteristics of components at the time of publication. The particular conditions of your use and application of our products are beyond our control. Thus, it is imperative that you test our products in your specific application to determine their suitability. All information is provided without implied or express warranty or guarantee by Nordson MEDICAL or other manufacturers. None of the information provided constitutes a recommendation or endorsement of any kind by Nordson MEDICAL.

Material - Manufacturer & Grade	VP Code	Regulatory Compliance of Base Resin*	RoHS Compliant	BPA Free	DEHP Free	Animal Derivative Free*
ABS (Lace White) - INEOS Lustran 348-000000	-81	USP Class VI Certified; ISO 10993 Part I Compliant	Yes	Yes	Yes	No
ABS, MABS (Methyl Methacrylate) - BASF Terlux 2802 TR	-8003, SCV Series	USP Class VI Certified	Yes	Yes	Yes	Yes
ABS (Sno White) - INEOS Lustran 348-012002	-8012	USP Class VI Certified; ISO 10993 Part I Compliant	Yes	Yes	Yes	No
al - DuPont Delrin 500P	-10	21 CFR 177.2480 FDA Approved	Yes	Yes	Yes	No
al Copolymer - BASF Ultraform N 23020 003	-1006, -1007	21 CFR 177.2470 FDA Approved	Yes	Yes	Yes	No
lic - Cyro Cyrolite Med 2	-50	USP Class VI Certified; ISO 10993 Compliant; 21 CFR 177.1010 FDA Approved	Yes	Yes	Yes	Yes
n (PA 66) - DuPont Zytel 101F	-0, -1, -2, -3, -4, -5, -06, -07, -08B, -8, -8B, -CM030	21 CFR 177.1500 FDA Approved	Yes	Yes	Yes	No
n (PA 66) - DuPont Zytel SC310 NC010	-U1, -U5, -U01, -U05	USP Class VI Certified; ISO 10993 Compliant; 21 CFR 177.1500 FDA Approved	Yes	Yes	Yes	No
n (Glass Reinforced) - DuPont Zytel FGFES171	-U71, -U75	USP Class VI Certified; ISO 10993 Compliant; 21 CFR 177.1500 FDA Approved	Yes	Yes	Yes	No
n (Glass Reinforced) - DuPont Zytel 70G33L	-7, -72	21 CFR 177.1500 FDA Approved	Yes	Yes	Yes	No
carbonate (Clear) - Bayer Makrolon 2568 550115	-9	USP Class VI Certified; ISO 10993 Compliant; 21 CFR 177.1580 FDA Approved	Yes	No	Yes	No
carbonate (Clear) - Bayer Makrolon Fx 1805 451118	-9010, SCV Series	USP Class VI Certified; ISO 10993 Compliant	Yes	No	Yes	Yes
carbonate (Tinted) - Sabic Lexan HPS1	-9024	USP Class VI Certified; ISO 10993 Compliant	Yes	No	Yes	No
carbonate (Tinted) - Styron Calibre Megarad 2081-15	-9002, DCV Series	ISO 10993 Compliant	Yes	No	Yes	No
ethylene - LyondellBasell Purell PE 1840 H	SCV Series	Please call for details	Yes	Yes	Yes	Yes
ethylene - Trilliant HC5420-0002 LL Natural Resin	-VP1	USP Class VI Certified	Yes	Yes	Yes	Yes
propylene - Flint Hills P5M6K-080	-6005, -6006	USP Class VI Certified; 21 CFR 177.1520 FDA Approved	Yes	Yes	Yes	Yes
sulfone - Solvay Udel PI1700 CL2611	-40	USP Class VI Certified; ISO 10993 Compliant; 21 CFR 177.1655 FDA Approved	Yes	Yes	Yes	Yes
PVDF - Arkema Kynar 1000 HD	-J1A	USP Class VI Certified; 21 CFR 177.2510 FDA Approved	Yes	Yes	Yes	Yes
SAN - BASF 388S TR 77770	SCV Series	ISO 10993 Compliant	Yes	Yes	Yes	No
Silicone - Wacker Elastosil LR 3003	SCV Series	USP Class VI Certified	Yes	Yes	Yes	Yes

*As determined by resin manufacturer

HROMalytic +61(0)3 9762 2034
ECHnology Pty Ltd
 Website NEW : www.chromalytic.net.au E-mail : info@chromtech.net.au Tel: 03 9762 2034 . . . in AUSTRALIA

Australian Distributors
 Importers & Manufacturers
www.chromtech.net.au

Material - Manufacturer & Grade	VP Code	Gamma Radiation Sterilization*	Ethylene Oxide Sterilization	Autoclave Sterilization
ABS (Lace White) - INEOS Lustran 348-000000	-81	Compatible up to 5 Mrads	Good	Not suitable due to low heat deflection temperatures
ABS, MABS (Methyl Methacrylate) - BASF Terluc 2802 TR	-8003, SCV Series	Withstands up to 5 Mrad doses without yellowing	Good	Poor: components may distort due to low heat deflection temperatures
ABS (Sno White) - INEOS Lustran 348-012002	-8012	Compatible up to 5 Mrads	Good	Not suitable due to low heat deflection temperatures
Acetal - DuPont Delfin 500P	-10	Compatible up to 1 Mrad	Excellent	Very good
Acetal Copolymer - BASF Ultratorm N 2320 003	-1006, -1007	Compatible up to 1.5 Mrads	Excellent	Very good
Acrylic - Cyro Cyrolite Med 2	-50	Very good up to commonly used doses (6 Mrads)	Excellent	Not recommended
Nylon (PA 66) - DuPont Zytel 101F	-0, -1, -2, -3, -4, -5, -06, -07	Very good; may discolor to brownish hue	Very good; some susceptibility to oxidizing agents	Very good; product may swell slightly due to water absorption
Nylon (PA 66) - DuPont Zytel SC310 NC010	-U1, U5, -U01, -U05	Very good; may discolor to brownish hue	Very good; some susceptibility to oxidizing agents	Very good; product may swell slightly due to water absorption
Nylon (Glass Reinforced) - DuPont Zytel 70G30L	-U71, -U75	Very good; may discolor to brownish hue	Very good; some susceptibility to oxidizing agents	Excellent
Nylon (Glass Reinforced) - DuPont Zytel 70G33L	-72	Very good; may discolor to brownish hue	Very good; some susceptibility to oxidizing agents	Excellent
Polycarbonate (Clear) - Bayer Makrolon 2558 5501 15	-9	Compatible up to 10 Mrads with minor loss of physical properties; will discolor to yellow-green hue	Highly compatible	Poor: may craze or stress crack due to molding stresses
Polycarbonate (Clear) - Bayer Makrolon FX 1805 4511 18	-9010, SCV Series	Compatible up to 10 Mrads with minor loss of physical properties; may discolor slightly dependent upon dose/number of cycles	Highly compatible	Poor: may craze or stress crack due to molding stresses
Polycarbonate (Tinted) - Sabic Lexan HFS1	-9024	Highly compatible with reduced color shift when compared to unstabilized polycarbonate resins	Highly compatible	Not recommended
Polycarbonate (Tinted) - Syron Calibre Megarad 2081-15	-9002, DCV Series	Excellent up to 10 Mrads with minor loss of physical properties; light violet hue turns clear upon sterilization	Highly compatible	Not recommended
Polyethylene - LyondellBasell Purell PE 1840 H	SCV Series	Compatible up to 5 Mrads	Highly compatible	Not recommended
Polyethylene - Trilliant HC5420-0002 LL Natural Resin	-VP1	Highly compatible	Highly compatible	Not recommended
Polypropylene - Flint Hills P5M6K-080	-6005, -6006, -6012	Very good to commonly used sterilization doses (6 Mrads)	Highly compatible	Limited to 121°C for 20 minutes at low heat deflection temperatures
Polysulfone - Solvay Udel P1 700 QL2611	-40	Highly compatible; will discolor to brownish hue	Excellent	Excellent
PVDF - Arkema Kyrar 1000 HD	-J1A	Highly compatible; will discolor to brownish hue	Excellent	Highly compatible
SAN - BASF 389S TR 77770	SCV Series	Compatible up to 5 Mrads	Good	Not suitable due to low heat deflection temperatures
Silicone - Wacker Elastosil LR 3003	SCV Series	Compatible up to 5 Mrads	Highly compatible	Very good

*1 Megarad (Mrad) = 10 kiloGrays (kGy)

TECHNICAL:

Common Resin Sterilization Stability

Property	ASTM Test Method	PVDF	Polycarb	Radiation Stable PC	Polypro	Nylona	GF Nylona	ABS	MABS	Polysulfone	Acetal
Tensile Strength	D638	5,400	10,000	9,800	—	12,000	27,000	4,800	—	—	—
Elongation at Break, %	D638	100-400	120	150	375	300	3	50	12	50-100	40
Tensile Yield Strength, psi	D638	6,500	9,200	9,800	4,400	12,000	—	5,700	6,960	10,200	9,900
Flexural Modulus, kpsi	D790	360	330	350	170	410	1,300	330	—	390	450
Rockwell Hardness D	D785	—	R118	R118	R80-102	R121	—	R107	—	—	R122
Rockwell Hardness M	—	—	M75	M72	—	M79	M101	—	—	M69	M89
Shore Hardness D	D2240	D76-80	—	—	—	—	—	—	—	—	—
Coef. of Linear 10-5 in/in/°F	D696	7.6	3.9	3.8	—	4	1.3	5.5	—	3.1	—
Deflection Temp°F @264psi	D648	244	266	252	—	194	480	173	194	345	216
Deflection Temp°F @66psi	D648	—	273	—	190	455	—	—	201	358	332
Water Absorption, %, 24 h	D570	0.015	0.15	0.15	0	1.2	0.7	0.25-0.40	0.7	0.3	0.4
Izod Impact, (Notched) ft-lb/in	D256	3.1	16.0	14.0	0.5	1.0	2.2	6.0	1.31	1.3	—

The data presented here is for reference only. It was compiled to provide our customers with a means of comparing the characteristics of components at the time of publication. The particular conditions of your use and application of our products are beyond our control. Thus, it is imperative that you test our products in your specific application to determine their suitability. All information is provided without implied or express warranty or guarantee by Nordson MEDICAL or other manufacturers. None of the information provided constitutes a recommendation or endorsement of any kind by Nordson MEDICAL.

TECHNICAL:
Trademarks

Trademark **1,428,380**



Corporate Trademark. The stylized design associated with Value Plastics® products and services.

To protect our intellectual property and our customers, it is important to be aware of the patents and trademarks that apply to our products. Look for the Value Plastics logo (V) to ensure you do not mistakenly use a poor quality counterfeit of a Value Plastics® fitting, thereby jeopardizing the integrity and quality of your product.

- BioClamp® is a registered trademark of BioPure Technology Ltd.
- BioValve® is a registered trademark of BioPure Technology Ltd.
- C-Flex® is a registered trademark of Consolidated Polymer Technologies, Inc.
- CYROLITE® Protect is a registered trademark of Evonik Corporation
- Dinamap® is a registered trademark of GE Healthcare
- Equistar® is a registered trademark of Equistar Chemicals
- Kynar® is a registered trademark of Atochem Atofina North America, Inc.
- Lubrizol® is a registered trademark of The Lubrizol Corporation
- Teknor® is a registered trademark of Teknor Apex Company
- Tuf-Flex® is a registered trademark of Rubber Fab Technologies Group

Trademark **1,887,178**

VALUE PLASTICS®

Corporate Trademark.

One or more components contained in this catalog may be covered by B. Braun OEM Division patents and trademarks. Patent numbers: 4,246,932; 4,535,820; 4,683,916.

©2015 Nordson MEDICAL. All rights reserved. No part of this catalog may be reproduced without the express consent of Nordson MEDICAL. All terms are current as of August 1, 2015 and are subject to change without notice.

Trademark **3,838,623**

BUILD-A-PART®

Trademark for our non-metal bondable fittings

Trademark **1,727,081**

TUBESETTER®

Trademark for our rapid assembly devices

OTHER TRADEMARKS

- 1,827,467
- 1,817,921
- 1,817,922
- 2,655,263
- 2,616,170
- 2,535,232
- 2,535,234

3PF210.....	84	16220.....	95	BDMK.....	101
3PF220.....	84	16230.....	95	BDML210.....	100
3PF230.....	84	16240.....	95	BDML220.....	100
4PDL210.....	85	16250.....	95	BDML230.....	100
4PDL220.....	85	16410.....	95	BDML410.....	100
4PDL230.....	85	16420.....	95	BDML420.....	100
4PLL210.....	85	16430.....	95	BDML430.....	100
4PLL220.....	85	16445.....	95	BDMM6.....	101
4PLL230.....	85	16450.....	95	BDMMTL.....	100
4PX210.....	84	18210.....	96	BDMR210.....	100
4PX220.....	84	18220.....	96	BDMR220.....	100
4PX230.....	84	18230.....	96	BDMR230.....	100
4PX655.....	55, 85	18240.....	96	BDMR240.....	100
4PX670.....	55, 85	18410.....	96	BDMR410.....	100
4PX680.....	55, 85	18420.....	96	BDMR420.....	100
6PDT210.....	85	18430.....	96	BDMR430.....	100
6PDT220.....	85	18445.....	96	BDMR445.....	100
6PDT230.....	85	AA.....	73	BDMRP.....	100
6PTT210.....	85	ABR004.....	93	BDMS.....	101
6PTT220.....	85	ABR007.....	93	BDMT210.....	101
6PTT230.....	85	ABR013.....	93	BDMT220.....	101
14MTLL.....	65	ABSML.....	65	BDMT230.....	101
18FTLL.....	66	AC.....	75	BDMT410.....	101
18L230.....	97	AD.....	75	BDMT420.....	101
18L250.....	97	AF7500077.....	103	BDMT430.....	101
18L260.....	97	AF7500155.....	103	BDMX.....	101
18LFTLL.....	66	AF7500311.....	103	BioClamp®.....	42
18MTLL.....	65	AF7500506.....	103	BioPharm Designer Kit.....	109
18T250.....	97	AF7500584.....	103	BioValve®.....	43
18T260.....	97	AF7500753.....	103	Blood Pressure Designer Kit.....	109
920PS.....	107	Assorted Designer Kit.....	108	Blood Pressure Fittings.....	68
930AS.....	107	B.....	89	BPA013.....	69
930B1A.....	107	Bag Ports.....	38	BPA025.....	69
930JS.....	107	Barb Dimensions.....	110	BPA035.....	69
1040.....	75	Barb Performance.....	112	BPA055.....	69
1050.....	76	BDF16.....	101	BPAM.....	69
1401.....	97	BDF18.....	101	BPC025.....	70
1402.....	97	BDFM6.....	101	BPC220.....	70
1600.....	95	BDFS.....	101	BPC230.....	70
1610.....	95	BDJ01.....	99	BPC240.....	70
1620.....	95	BDJ02.....	99	BPC250.....	70
1630.....	95	BDJ03.....	99	BPCL025.....	70
1640.....	95	BDJ04.....	99	BPCL220.....	70
1650.....	95	BDJ05.....	99	BPCL230.....	70
1800.....	97	BDJ06.....	99	BPCL240.....	70
1801.....	97	BDJ07.....	99	BPCL250.....	70
1802.....	97	BDJ08.....	99	BPF220.....	68
1810.....	96	BDJ09.....	99	BPF230.....	68
1820.....	96	BDJ10.....	99	BPF240.....	68
1830.....	96	BDJ11.....	99	BPF250.....	68
1840.....	96	BDJ12.....	99	BPF Series Properties & Performance..	113
1850.....	96	BDJ13.....	99	BPLF230.....	71
1860.....	96	BDJ14.....	99	BPLF240.....	71
2040.....	75	BDJ15.....	99	BPLM230.....	71
2050.....	76	BDJ16.....	99	BPLM240.....	71
3040.....	76	BDJ17.....	99	BPM013.....	13, 69
3050.....	76	BDJ18.....	99	BPM025.....	13, 69
3060.....	76	BDJ19.....	99	BPM035.....	13, 69
4040.....	73	BDJ20.....	99	BPM240.....	13, 69
4050.....	76	BDJ21.....	99	BPMB230.....	69
4060.....	76	BDJ22.....	99	BPMB240.....	69
5050.....	74	BDM16.....	101	BPMB250.....	69
5060.....	77	BDM18.....	101	BPMMTLL.....	69
6060.....	74	BDMD.....	100	BSFTLL.....	66
16210.....	95	BDMFTLL.....	100	BSMLRL.....	65

Build-A-Part® Designer Kit	109	FTLL025	62	L30.....	78
Build-a-Part® Fittings	99	FTLL035	62	L40.....	78
C	89	FTLL055	62	L50.....	78
CA091	64	FTLL210	61	L60.....	78
CC	73	FTLL220	61	LO70.....	53, 79
CCLR	67, 87	FTLL230	61	LO70/055.....	53, 80
CCR	67, 87	FTLL240	62	L080.....	53, 79
CF229	70	FTLL250	62	L080/070.....	53, 80
CF230	70	FTLL360	62	L090.....	53, 79
CF494	53, 79	FTLL410	61	L100.....	53, 79
Check Valves	30	FTLL420	61	L100/080.....	53, 80
Chemical Resistance of Resin.....	114	FTLL430	61	L110.....	53, 79
CPAN75.....	46	FTLL445	62	L110/100.....	53, 80
CPAX150	46	FTLL450	62	L210.....	78
CPN75	47	FTLLB210.....	66	L220.....	78
CPT100	47	FTLLB220.....	66	L220/210.....	79
CPX150.....	47	FTLLB230.....	66	L230.....	78
D	89	FTLLBMLRL.....	66	L230/210.....	79
DC.....	75	FTLLC.....	63	L230/220.....	79
DCV114.....	33	FTLLE.....	63	L410.....	78
DCV115.....	33	FTLLP.....	64	L420.....	78
DCV118.....	33	FTLLSB004.....	62	L420/410.....	79
DCV125.....	33	FTLLSB007.....	62	L430.....	78
DD.....	73	FTLLSB013.....	62	L430/220.....	79
Design Center	14	FTLP.....	64	L430/410.....	79
Designer Kits.....	108	FTLT	63	L430/420.....	79
Double Check Valves.....	33	G40MPGR-TF150.....	44	L440.....	78
Elbow Connectors.....	78	G42MPGR-TF075.....	44	L970.....	53, 79
ENTFE098	13	G424TRX-0200	44	L975.....	53, 79
ENTFTC	13	G424TRX-0300	44	L6110.....	53, 79
ENTM230	13	Gaskets	44	LC34	63
ENTME050	13	GMN450.....	44	LC78	63
ENTME064	13	GMX455	44	LE87	63
ENTME078	13	Ink Jet Designer Kit.....	109	LE7220.....	63
ENTME098	13	ISO 80369.....	10	LE7230.....	64
ENTMTP	13	ISO 80369-3 Compliant Connectors...	12	LLDPE01-1019C.....	103
FCA021	36	ISO 80369-5 Compliant Connectors...	13	LLDPE01-1019M.....	103
FCFFM.....	37	ISO 80369 Compliant Connectors	12	LLDPE01-1031C.....	103
FCFFMR	37	K10	89	LLDPE01-1031M.....	103
FCFM	36	K210	89	LLDPE01-2031C.....	103
FCFMR	36	K220	89	LLDPE01-2031M.....	103
FCHPFFMR.....	37	K230	89	LLDPE01-3031C.....	103
FCLBFFM	37	K240	89	LLDPE01-3031M.....	103
FCLBFFM-1A.....	37	K410	89	LNS	67, 87
FCLBFFMR-1A.....	37	K420	89	LP4.....	64
FLB035.....	106	K430	89	LP34.....	64
FLB055.....	106	K445	89	LT787	63
FLB065.....	106	KFTL	66	LT878	63
FLBP.....	106	KFTLL.....	66	Luer Designer Kit.....	108
FSLLR.....	60, 63	KL210.....	90	Luers	58
FTL10	62	KL220.....	90	M6P.....	94
FTL20	62	KL230.....	90	M5210.....	94
FTL30	62	KL410.....	90	M5220.....	94
FTL210.....	62	KL420.....	90	M5230.....	94
FTL220.....	62	KL430.....	90	M5240.....	94
FTL230.....	63	KN.....	92	M6210.....	94
FTL240.....	63	KP	92	M6220.....	94
FTLB210.....	67	KT210	91	M6230.....	94
FTLB220.....	67	KT220	91	M6240.....	94
FTLB230.....	67	KT230	91	M6250.....	94
FTLC	63	KT410	91	M6410.....	94
FTLE	63	KT420	91	M6420.....	94
FTLL004	61	KT430	91	M6430.....	94
FTLL007	61	L10.....	78	M6445.....	94
FTLL013	61	L20.....	78	M6450.....	94

Manifold Connectors	84	MTLSP.....	64	N6110/6100	52, 77
Manual Tubesetter®	107	Multiport Connectors	84	NVF13VPC.....	35
MLB035.....	105	N004	73	NVF20PC.....	35
MLB055.....	105	N007	73	NVF20VPC.....	35
MLB065.....	105	N007/004	75	NVF25PC.....	35
MLBC7	105	N013	73	NVF28PC.....	35
MLBC8	105	N013/004	75	NVF37PC.....	35
MLBP	106	N013/007	75	NVF41PC.....	35
MLRL004	60	N025	73	NVFBGPC.....	35
MLRL007	60	N025/004	75	NVFBV60PC	35
MLRL013.....	60	N025/007	75	NVFBV66PC	35
MLRL025.....	60	N025/013.....	76	NVFMLLCP	34
MLRL035.....	60	N035	74	NVFMLLPC	34
MLRL055.....	60	N035/007	76	NVFMMLPC	35
MLRLB210.....	67	N035/013	76	NVFSMMLPC	35
MLRLB220.....	67	N035/025	76	NVFTPC.....	35
MLRLB230.....	67	N055	74	NVfy36PC.....	35
MLRLC	63	N055/013.....	76	NVfy401CP.....	35
MLRLP	64	N055/025.....	76	NVfy401PC.....	35
MLSL004	60	N055/035	77	Opposing Barb Ports	41
MLSL007	60	N065	74	Panel Mount Instructions.....	113
MLSL013.....	60	N065/025.....	77	PharmaLok™ Clamps	46
MLSL025.....	60	N065/035.....	77	PIP10.....	86
MLSL035.....	60	N065/055.....	77	PIP20.....	86
MLSL055.....	60	N070	52, 74	PIP30.....	86
MLSLP.....	64	N070/013.....	52, 77	PIP40.....	86
MQCF230.....	16	N070/055.....	52, 77	PIP50.....	86
MQCF240.....	16	N080	52, 74	PIP60.....	86
MQCF250.....	16	N080/055.....	52, 77	PIP070.....	55, 86
MQCMF230.....	17	N080/070	52, 77	PIP080.....	55, 86
MQCMF240.....	17	N090	52, 74	PIP090.....	55, 86
MQCMF250.....	17	N090/055.....	52, 77	PIP210.....	86
MQCRM230	17	N090/070	52, 77	PIP220.....	86
MQCRM240	17	N100	52, 74	PIP230.....	86
MQCRM250	17	N100/080	52, 77	PIP240.....	86
MSL004.....	61	N110	52, 74	PIP670.....	55, 86
MSL007.....	61	N110/100.....	52, 77	PIP680.....	55, 86
MSL013.....	61	N210	73	PIP6100.....	55, 86
MSL025.....	61	N220	73	PIP6110.....	55, 86
MSL035.....	61	N220/210	75	Plug Connectors	86
MSL055.....	61	N230	73	PM2N	69
MTLCS	63	N230/210	75	PM3N	69
MTLL004	59	N230/220	75	PM4N	29
MTLL007	59	N410	73	PMK210	87
MTLL013	59	N420	73	PMK220	87
MTLL025	59	N420/410.....	75	PMK220-210.....	87
MTLL035	59	N430	73	PMKN.....	67, 87
MTLL055	59	N430/410.....	75	PMS230	87
MTLL210	59	N430/420.....	75	PMS230-210.....	87
MTLL220	59	N440	73	PMS230-220.....	87
MTLL230	59	N670	52, 74	PMSN.....	67, 69, 87
MTLL240	59	N670/655.....	52, 77	PQCBF3230-AC-001	19
MTLL250	59	N680	52, 74	PQCBF3230-PP-001	19
MTLL360	59	N680/655.....	52, 77	PQCBF3230-PP-002	19
MTLL410	59	N680/670	52, 77	PQCBF3260-AC-001	19
MTLL420	59	N690	52, 74	PQCBF3260-PP-001	19
MTLL430	59	N690/655.....	52, 77	PQCBF3260-PP-002	19
MTLL445	59	N690/670.....	52, 77	PQCBM3230-AC-001	23
MTLL450	59	N970	52, 74	PQCBM3260-AC-001	23
MTLLP	64	N975	52, 74	PQCF14-AC-001	17
MTLP	64	N6100	52, 74	PQCF14-PP-001.....	17
MTLS210.....	61	N6100/670.....	52, 77	PQCF14-PP-002.....	17
MTLS220.....	61	N6100/680.....	52, 77	PQCF18-AC-001	17
MTLS230.....	61	N6110	52, 74	PQCF18-PP-001.....	17
MTLS240.....	61	N6110/680.....	52, 77	PQCF18-PP-002.....	17

PQCF3230-AC-001	18	Quick Connect Fittings.....	16	SCV22050.....	31
PQCF3230-PP-001.....	18	RB01	100	SCV23050.....	32
PQCF3230-PP-002.....	18	Reducer Connectors	75	SCV25052.....	32
PQCF3260-AC-001	18	Resin Sterilization Stability	116	SCV67220.....	32
PQCF3260-PP-001.....	18	RMLLR.....	100	SCV67220/230.....	32
PQCF3260-PP-002.....	18	RQCF655	24, 48	SCV67220/ML.....	32
PQCLM3230-AC-001	22	RQCF670	24, 48	SCV67230.....	32
PQCLM3230-PP-001.....	22	RQCFC.....	24, 48	SCV67230/220.....	32
PQCLM3230-PP-002.....	22	RQCFL655	24, 48	SCV67230/ML.....	32
PQCLM3260-AC-001	22	RQCFL670	24, 48	SFBP630.....	39
PQCLM3260-PP-001.....	22	RQCFLC.....	24, 48	SFBP635-635.....	41
PQCLM3260-PP-002.....	22	RQCM655	24, 48	SFBP655.....	39
PQCM14-AC-001	20	RQCM670	24, 48	SFBP655-655.....	41
PQCM18-AC-001	20	RQCMP	24, 48	SFBP670.....	39
PQCM18-PP-001.....	20	RQXF670.....	25, 49	SFBP670-670.....	41
PQCM18-PP-002.....	20	RQXF680.....	25, 49	SFBP680.....	39
PQCM3230-AC-001	21	RQXFC.....	25, 49	SFBP680-680.....	41
PQCM3230-PP-001.....	21	RQXFL670.....	25, 49	SFBP6100.....	39
PQCM3230-PP-002.....	21	RQXFL680.....	25, 49	SFBP6100-6100.....	41
PQCM3260-AC-001	21	RQXFLC.....	25, 49	SFBP6110.....	39
PQCM3260-PP-001.....	21	RQXM670.....	25, 49	SFBPF1	40
PQCM3260-PP-002.....	21	RQXM680.....	25, 49	SFBPF3	40
PQCVBF3230-AC-001	20	RQXMP.....	25, 49	SFMN655.....	50
PQCVBF3230-PP-001.....	20	S10	92	SFMN670.....	50
PQCVBF3230-PP-002.....	20	S20	92	SFMN680.....	50
PQCVBF3260-AC-001	20	S30	92	SFMN6100.....	50
PQCVBF3260-PP-001.....	20	S40	93	SFMNC.....	50
PQCVBF3260-PP-002.....	20	S50	93	SFMX655.....	51
PQCVBM3230-AC-001.....	23	S210.....	92	SFMX670.....	51
PQCVBM3260-AC-001.....	23	S220.....	92	SFMX680.....	51
PQCVF14-AC-001	18	S230.....	92	SFMX6100.....	51
PQCVF14-PP-001.....	18	S240.....	93	SFMX6110.....	51
PQCVF14-PP-002.....	18	S250.....	93	SFMXC.....	51
PQCVF18-AC-001	18	S410.....	92	SFTL.....	66
PQCVF18-PP-001.....	18	S420.....	92	SFTLL.....	66
PQCVF18-PP-002.....	18	S430.....	93	SILC7001098	103
PQCVF3230-AC-001	19	S445.....	93	SILC7001657	103
PQCVF3230-PP-001.....	19	S450.....	93	SILC7002203	103
PQCVF3230-PP-002.....	19	Sanitary Fittings.....	50	SILC7002593	103
PQCVF3260-AC-001	19	SBLF013	26	SILC7002775	103
PQCVF3260-PP-001.....	19	SBLF035	26	SILC7003139	103
PQCVF3260-PP-002.....	19	SBLM013	26	SMLRL.....	65
PQCVLM3230-AC-001	23	SBLM035	26	SMTLL.....	65
PQCVLM3230-PP-001.....	23	SBLMFBG013.....	26	SP	93
PQCVLM3230-PP-002.....	23	SBLMFBG035.....	26	T10.....	80
PQCVLM3260-AC-001	23	SBLMFBG013.....	26	T013.....	80
PQCVLM3260-PP-001.....	23	SBLMFBG035.....	26	T20.....	80
PQCVLM3260-PP-002.....	23	SCV67FL/220.....	32	T30.....	80
PQCVM14-AC-001	21	SCV67FL/230.....	32	T40.....	80
PQCVM18-AC-001	21	SCV06018.....	30	T055.....	81
PQCVM18-PP-001.....	21	SCV06246.....	31	T60.....	80
PQCVM18-PP-002.....	21	SCV06248.....	31	T070.....	54, 81
PQCVM3230-AC-001	22	SCV06249.....	31	T070/055	54, 82
PQCVM3230-PP-001.....	22	SCV06252.....	31	T080.....	54, 81
PQCVM3230-PP-002.....	22	SCV06264.....	31	T080/055	54, 82
PQCVM3260-AC-001	22	SCV06265.....	31	T080/070	54, 82
PQCVM3260-PP-001.....	22	SCV06272.....	31	T100.....	54, 81
PQCVM3260-PP-002.....	22	SCV06308.....	30	T100/080	54, 82
PV00-1031C.....	102	SCV06329.....	31	T110.....	54, 81
PV00-1031M.....	102	SCV06335.....	30	T110/100	54, 82
PV00-2047C.....	102	SCV06352.....	31	T210.....	80
PV00-3062C.....	102	SCV08053.....	31	T210/220	81
PV00-3062M.....	102	SCV10090.....	31	T210/230	81
PV00-5062C.....	102	SCV17090.....	31	T220.....	80
PV00-6062C.....	102	SCV21053.....	31	T220/210	81

T220/230	81	UR00-3062C	103	XQSF755	27
T220R210	81	VBV0500NW	43	XQSF770	27
T230	80	VBV1000NW	43	XQSVBF755	28
T230/210	82	VLP4	64	XQSVBF770	28
T230/220	82	VNG075WHT	42	XQSVF755	27
T230R210	82	VNG150WHT	42	XQSVF765	27
T230R220	82	VNG200WHT	42	XQSVF770	27
T250	80	VNG250WHT	42	XT210	91
T360/220	82	VNG300WHT	42	XT220	91
T360/230	82	VNG400WHT	42	XT230	91
T360/250	82	VNG600WH	42	XT410	91
T410	80	VNG800WH	42	XT420	91
T410/420	81	VPB0850400N	106	XT430	91
T410/430	81	VPB1000050N	36	Y013	83
T420	80	VPB1000055N	37	Y055	84
T420/410	81	VPB1000062N	37	Y070	55, 84
T420/430	81	VPB1000079N	37	Y080	55, 84
T420R410	81	VPB1000099N	37	Y090	55, 84
T430	80	VPB1000110N	37	Y100	55, 84
T430/410	82	VPM0480201N	106	Y110	55, 84
T430/420	82	VPM1060200N	106	Y210	83
T430R410	82	VPM1080303N	106	Y220	83
T430R420	82	VPM2930601N	106	Y230	83
T670	54, 81	VPS3901074N	106	Y240	83
T680	54, 81	VPS5069200N	106	Y250	83
T690	54, 81	VPS5401001N	32	Y260	83
T970	54, 81	VPS5401020N	32	Y410	83
T975	54, 81	VPS5401036SN	32	Y420	83
T6100	54, 81	VPS5401068N	32	Y430	83
T6110	54, 81	X10	89	Y450	83
Tapered Seal	104	X210	89	Y460	83
TBA2025-001	57	X220	89	Y670	55, 84
TBA2025-002	57	X230	89	Y680	55, 84
TBA2040-001	57	X240	89	Y690	55, 84
TBA2052-001	57	X410	89	Y6100	55, 84
TBA2062-001	57	X420	89	Y6110	55, 84
TBA2081-001	57	X430	89	Y Connectors	83
TBA2100-001	57	X445	89		
TBA3084-001	57	XFTL	66		
TBA4030P-001	57	XFTLL	66		
TBA4030P-002	57	XL210	90		
TECS116	93	XL220	90		
TECS118	93	XL230	90		
Tee Connectors	80	XL410	90		
Threaded Connectors	88	XL420	90		
Trademarks	117	XL430	90		
TSC2F007	105	XMLRL	65		
TSC2F013	105	XMTLL	65		
TSC2F035	105	XN	92		
TSC2F210	105	XP	92		
TSC2FB230	105	XQCBM755	29		
TSC2M013	104	XQCBM770	29		
TSC2M035	104	XQCLM755	29		
TSC2M210	104	XQCLM770	29		
TSC2MP	105	XQCM755	28		
Tube-to-Tube Connectors	72	XQCM770	28		
Tube-to-Tube Designer Kit	108	XQCVBM755	29		
Typical Resin Properties	117	XQCVBM770	29		
U10	87	XQCVM755	28		
U20	87	XQCVM765	28		
U30	87	XQCVM770	28		
UR00-1031C	103	XQ Designer Kit	108		
UR00-1031M	103	XQSBF755	27		
UR00-2047C	103	XQSBF770	27		
UR00-2047M	103				