

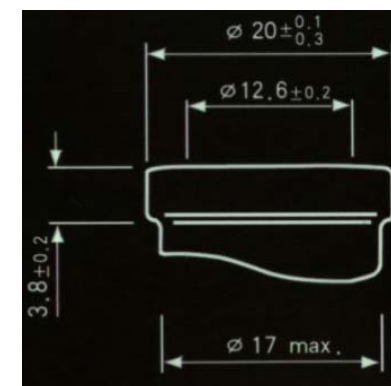





Clear Moulded Injection Vials – 20mm crimp finish Type II





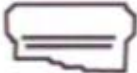

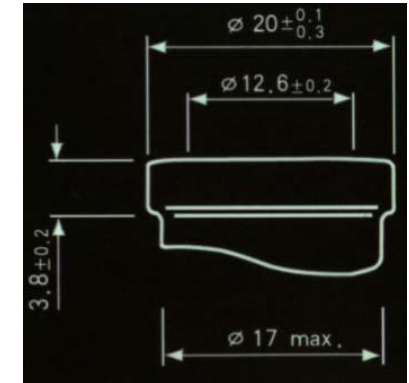

Product Code								Carton Quantity CT
CT110201C	20mL	20	26	29.0	20mm	58.0	32.0	480
CT110301C	30mL	30	38	35.0	20mm	62.8	36.0	276
CT110501C	50mL	50	60	50.0	20mm	73.0	42.5	336
CT111001C	100mL	100	119	89.0	20mm	94.5	51.6	198

HROMalytic Chromatography
Australian Distributors **ECH**nology **Products '08**

Amber Moulded Injection Vials – 20mm crimp finish Type II

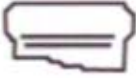







Product Code								Carton Quantity
CT410201A	20mL	20	26	29.0	20mm	58.0	32.0	480
CT410301A	30mL	30	38	35.0	20mm	62.8	36.0	276
CT410501A	50mL	50	60	50.0	20mm	73.0	42.5	336
CT411001A	100mL	100	119	89.0	20mm	94.5	51.6	198

HROMalytic Chromatography
Australian Distributors **ECH**nology **Products '08**

Clear Borosilicate Glass Type 1 - 20mm crimp finish

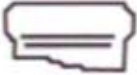







Product Code								Carton Quantity CTC
CT220075C	7.5mL	7.5	8.50	14.0	20mm	36.2	24.6	
CT220501C	10mL	10	13.0	20.0	20mm	50.1	24.6	
CT220302C	30mL	30	37.0	38.0	20mm	61.5	27.8	
CT220504C	20mL	50	68.0	60.0	ISO32	68.0	46.0	
CT221004C	100mL	100	128.00	100.0	ISO32	104.0	49.0	

Chromatography
Australian Distributors

Products '08



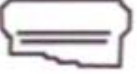



Clear Borosilicate Glass Type 1 - 20mm crimp finish



Product Code								Carton Quantity CT
CT220101C	10mL	10	15	21.0	ISO/SFDA	53.5	25.4	
CT220201C	20mL	20	26	29.0	ISO/SFDA	58.0	32.0	
CT220301C	30mL	30	38	35.0	ISO/SFDA	62.8	36.0	
CT220501C	50mL	50	60	50.0	ISO/SFDA	73.0	42.5	
CT221001C	100mL	100	128	100	ISO 32	104	49.0	

Amber Glass Bottle for Syrups – Pilfer-Proof Finish Type II

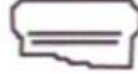









Product Code								Carton Quantity CT
CT480151A	15mL	15	19.0	29.5	21mm	62.0	28.2	540
CT480251A	25mL	25	29.0	38.5	23mm	71.9	30.8	352
CT480301A	30mL	30	35.0	48.0	PP 22	89.0	30.0	300
CT511001A	100mL	100	130.0	100	PP 25	114.0	47.0	120
CT512001A	200mL	200	215.0	165	PP 25	134.0	58.0	72

Chromatography
Products '08
Australian Distributors ECHnology

Amber Moulded Drop Dispensing Bottles – DIN 18mm



Product Code									Carton Quantity
CT490101A	10mL	10	12.5	27.5	DIN 18	58.0	24.8	768	
CT490151A	15mL	15	20	35	DIN 18	65.0	28.5	420	
CT490301A	30mL	30	35	48	DIN 18	78.8	33.0	345	
CT490501A	50mL	50	57	55	DIN 18	92.2	37.5	264	
CT491001A	100mL	100	105	88	DIN 18	112.0	44.5	140	

Chromatography Products '08
Australian Distributors **ECHnology**

Freeze Drying Closures for Injection Vials 13mm & 20mm



Ref No.: CT722002
Size: 20.00mm
OD of Flange: 18.80mm
ID of Neck: 13.20mm
Height of Flange: 03.30mm
Total Height: 14.00mm
Pack Size: 1,000 units

Ref No.: CT721302
Size: 13.00mm
OD of Flange: 12.50mm
ID of Neck: 07.50mm
Height of Flange: 02.00mm
Total Height: 10.20mm
Pack Size: 1,000 units

Ref No.: CT722003
Size: 20.00mm
OD of Flange: 18.80mm
ID of Neck: 13.10mm
Height of Flange: 03.30mm
Total Height: 13.80mm
Pack Size: 1,000 units



Closures for Injection Vials 13mm & 20mm



Ref No.: CT712001
Size: 20.00mm
OD of Flange: 18.80mm
ID of Neck: 13.20mm
Height of Flange: 03.30mm
Total Height: 14.00mm
Pack Size: 1,000 units

Ref No.: CT711311
Size: 13.00mm
OD of Flange: 12.50mm
ID of Neck: 07.50mm
Height of Flange: 02.00mm
Total Height: 07.00mm
Pack Size: 1,000 units

Ref No.: CT722003
Size: 20.00mm
OD of Flange: 18.80mm
ID of Neck: 13.10mm
Height of Flange: 03.30mm
Total Height: 13.80mm
Pack Size: 1,000 units

Amber Glass Bottles for Syrups DIN PP 28 mm



Price per 1K
F.I.S







30mL	30	35.00	35.00	DIN 28	67.00	35.0	\$60.00
60mL	60	67.50	60.00	DIN 28	94.00	38.6	\$67.50
100mL	100	108.0	72.00	DIN 28	104.8	46.1	\$98.00
200mL	200	209.0	120.00	DIN 28	113.3	57.0	\$154.00

Chromatography
Products '08
Australian Distributors

www.chromtech.net.au E-mail : info@chromtech.net.au Tel : +61 3 9762 2034 Fax : +61 3 9761 1169

Clear Infusion Bottles Type II

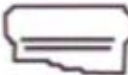

Product Code								Carton Quantity
CT510501C	50mL	50	68	60.00	ISO 32	68	46.0	
CT510508C	50mL	50		76.00	28.0mm	80	45.3	
CT510502C	50mL	50		73.50	SFDA 28.3	78	46.0	
CT211003C	100mL	100		99.50	28.8mm	96	52.0	
CT211001C	100mL	100	128	100.0	ISO 32	104	49.0	
CT511002C	100mL	100		110.0	SFDA 28.3	110	53.0	

Chromatography
Products '08
Australian Distributors

Aluminium Plastic Multi – Cap

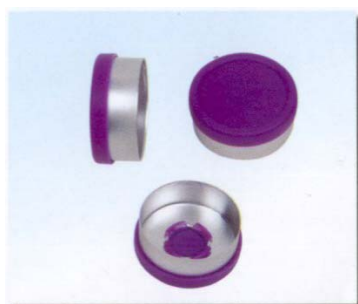

Ref No.: CT810131
Size: 13mm
d1: 13.3
d2: 15min. 16 max
d3: 3 min 8 max
h1: 6.3
h2: 7.3min 8.4 max
e: 0.168 ~ 0.242

Ref No.: CT810202
Size: 20mm
d1: 20.3
d2: 22.2min 23.2max
d3: 6 min 10 max
h1: 7.3
h2: 8.7min 9.8 max
e: 0.168 ~ 0.242

Ref No.: CT810201
Size: 20mm
d1: 20.3
d2: 22.2min 23.2max
d3: 6 min 10 max
h1: 7.3
h2: 8.7min 9.8 max
e: 0.168 ~ 0.242

Ref No.: CT810204
Size: 20mm
d1: 20.0
d2: 20.0min 23.0 max
d3: 6 min 10 max
h1: 7.3/6.9
h2: 8.7 min
e: 0.68 ~ 0.242

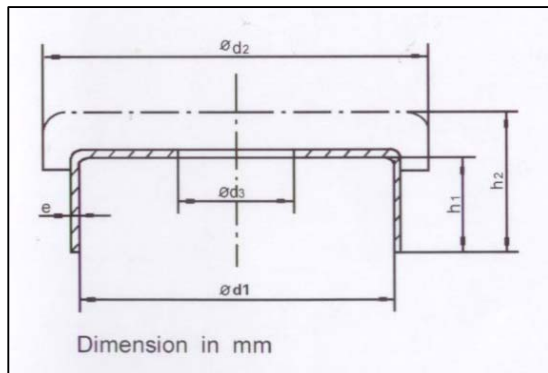







Ref No.: CT810203
Size: 20mm
d1: 20.0
d2: 20.0min 23.0 max
d3: 6 min 10 max
h1: 7.3/6.9
h2: 8.7 min
e: 0.68 ~ 0.242

Ref No.: CT810281
Size: 28mm
d1: 28.6
d2: 31.2 min 32.2 max
d3: 12 min 17 max
h1: 9.6
h2: 10.5 min 12 max
e: 0.168 ~ 0.242

Ref No.: CT810321
Size: 32mm
d1: 32.6
d2: 35.5 min 37 max
d3: 15 min 20 max
h1: 12.1
h2: 13 min 16 max
e: 0.168 ~ 0.242

Amber Glass Boston Round – G.P. I 400-18,20,22 mm

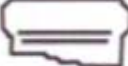

Product Code								Carton Quantity
CT430151	½ oz	14.2	16.4	25.5	18mm – 400	68.26		25.0
CT430301	1 oz	31.3	36.2	44.0	20mm – 400	78.56		32.8
CT430601	2 oz	60.8	63.6	58.0	20mm – 400	93.66		38.6
CT431201	4 oz	120.00	125.7	108.0	22mm - 400	112.73		48.82

HROMalytic Chromatography
Australian Distributors **ECH**nology **Products '08**